



Lenovo ThinkSystem SR665 V3 Server

Product Guide

The Lenovo ThinkSystem SR665 V3 is a 2-socket 2U server that features the AMD EPYC 9004 "Genoa" family of processors. With up to 128 cores per processor and support for the new PCIe 5.0 standard for I/O, the SR665 V3 offers the ultimate in two-socket server performance in a 2U form factor. The server is ideal for dense workloads that can take advantage of GPU processing and high-performance NVMe drives.

Suggested uses: Inference, virtualization, VDI, HPC, Hyperconverged infrastructure



Figure 1. Lenovo ThinkSystem SR665 V3

Did you know?

The SR665 V3 server is a very configuration-rich offering, supporting 30 different drive bay configurations in the front, middle and rear of the server and 6 different slot configurations at the rear of the server. This level of flexibility ensures that you can configure the server exactly the way your workload requires.

Key features

Combining performance and flexibility, the SR665 V3 server is a great choice for enterprises of all sizes. The server offers a broad selection of drive and slot configurations and offers high performance features that industries such as finance, healthcare and telco need. Outstanding reliability, availability, and serviceability (RAS) and high-efficiency design can improve your business environment and can help save operational costs.

Scalability and performance

The following features boost performance, improve scalability and reduce costs:

- Supports one or two fourth-generation AMD EPYC 9004 processors
 - Up to 128 cores and 256 threads
 - Core speed of up to 4.1 GHz
 - TDP rating of up to 360 W
- Support for DDR5 memory DIMMs to maximize the performance of the memory subsystem:
 - Up to 24 DDR5 memory DIMMs, 12 DIMMs per processor
 - 12 memory channels per processor (1 DIMM per channel)
 - DIMM speeds up to 4800 MHz
 - Using 256GB 3DS RDIMMs, the server supports up to 6TB of system memory
- Supports up to eight single-width GPUs or three double-wide GPUs, for substantial processing power in a 2U system.
- The server is Compute Express Link (CXL) v1.1 Ready. With CXL 1.1 for next-generation workloads, you can reduce compute latency in the data center and lower TCO. CXL is a protocol that runs across the standard PCIe physical layer and can support both standard PCIe devices as well as CXL devices on the same link.
- Supports up to 40x 2.5-inch hot-swap drive bays, by using combinations of front-accessible (up to 24 bays), mid bays (8 bays) and rear-accessible (8 bays).
- Supports 20x 3.5-inch drive bays for lower-cost high-capacity HDD storage. 2.5-inch and 3.5-inch drive bays can be mixed if desired.
- Supports up to 32x NVMe drives without oversubscription of PCIe lanes (1:1 connectivity). The use of NVMe drives maximizes drive I/O performance, in terms of throughput, bandwidth, and latency.
- Supports up to 20x SATA drives using the onboard SATA controller (no additional adapter needed), enabling lower cost, high capacity storage solution for cold storage workloads.
- Supports high-speed RAID controllers from Lenovo and Broadcom providing 12 Gb SAS connectivity to the drive backplanes. A variety of PCIe 3.0 and PCIe 4.0 RAID adapters are available.
- Supports two externally accessible 7mm hot-swap drives for operating system boot functions or data storage. Optional RAID with the addition of a RAID adapter installed in a slot.
- Supports M.2 drives for convenient operating system boot functions or data storage. Available M.2 adapters support either one M.2 drive or two M.2 drives. Optional RAID with the addition of a RAID adapter installed in a slot.
- Up to 12x PCIe slots (10x rear, 2x front), plus a slot dedicated to an OCP 3.0 adapter. 2.5-inch drive configurations also support an additional internal bay for a cabled RAID adapter or HBA.
- The server has a dedicated industry-standard OCP 3.0 small form factor (SFF) slot, with a PCIe 5.0 x16 interface, supporting a variety of Ethernet network adapters. Simple-swap mechanism with thumbscrews and pull-tab enables tool-less installation and removal of the adapter. Supports shared BMC network sideband connectivity to enable out-of-band systems management.
- The server offers PCI Express 5.0 (PCIe Gen 5) I/O expansion capabilities that doubles the theoretical maximum bandwidth of PCIe 4.0 (32GT/s in each direction for PCIe 5.0, compared to 16 GT/s with PCIe 4.0). A PCIe 5.0 x16 slot provides 128 GB/s bandwidth, enough to support a 400GbE network connection.

Availability and serviceability

The server provides many features to simplify serviceability and increase system uptime:

- Designed to run 24 hours a day, 7 days a week
- The server uses ECC memory and supports memory RAS features including Single Device Data Correction (SDDC, also known as Chipkill), Patrol/Demand Scrubbing, Bounded Fault, DRAM Address Command Parity with Replay, DRAM Uncorrected ECC Error Retry, On-die ECC, ECC Error Check and Scrub (ECS), and Post Package Repair.
- The server offers hot-swap drives, supporting RAID redundancy for data protection and greater system uptime.
- Available M.2 configuration with RAID support which can enable two SATA or two NVMe M.2 drives to be configured as a redundant pair.
- The server has up to two hot-swap redundant power supplies and up to six hot-swap redundant fans to provide availability for business-critical applications.
- Optional front-accessible slots and drives so that most major components and cables (except power) are located at the front of the server
- The power-source-independent light path diagnostics uses LEDs to lead the technician to failed (or failing) components, which simplifies servicing, speeds up problem resolution, and helps improve system availability.
- Solid-state drives (SSDs) offer more reliability than traditional mechanical HDDs for greater uptime.
- Proactive Platform Alerts (including PFA and SMART alerts): Processors, voltage regulators, memory, internal storage (SAS/SATA HDDs and SSDs, NVMe SSDs, M.2 storage, flash storage adapters), fans, power supplies, RAID controllers, server ambient and subcomponent temperatures. Alerts can be surfaced through the XClarity Controller to managers such as Lenovo XClarity Administrator, VMware vCenter, and Microsoft System Center. These proactive alerts let you take appropriate actions in advance of possible failure, thereby increasing server uptime and application availability.
- The built-in XClarity Controller 2 continuously monitors system parameters, triggers alerts, and performs recovery actions in case of failures to minimize downtime.
- Built-in diagnostics in UEFI, using Lenovo XClarity Provisioning Manager, speed up troubleshooting tasks to reduce service time.
- Lenovo XClarity Provisioning Manager supports diagnostics and can save service data to a USB key drive or remote CIFS share folder for troubleshooting and reduce service time.
- Auto restart in the event of a momentary loss of AC power (based on power policy setting in the XClarity Controller service processor)
- Offers a diagnostics port on the front of the server to allow you to attach an external diagnostics handset for enhanced systems management capabilities.
- Support for the XClarity Administrator Mobile app running on a supported smartphone and connected to the server through the service-enabled USB port, enables additional local systems management functions.
- Three-year or one-year customer-replaceable unit and onsite limited warranty, 9 x 5 next business day. Optional service upgrades are available.

Manageability and security

Systems management features simplify local and remote management:

- The server includes an XClarity Controller 2 (XCC2) to monitor server availability. Optional upgrade to XCC Platinum to provide remote control (keyboard video mouse) functions, support for the mounting of remote media files, FIPS 140-3 security, enhanced NIST 800-193 support, boot capture, power capping, and other management and security features.

- Lenovo XClarity Administrator offers comprehensive hardware management tools that help to increase uptime, reduce costs and improve productivity through advanced server management capabilities.
- UEFI-based Lenovo XClarity Provisioning Manager, accessible from F1 during boot, provides system inventory information, graphical UEFI Setup, platform update function, RAID Setup wizard, operating system installation function, and diagnostic functions.
- Support for Lenovo XClarity Energy Manager which captures real-time power and temperature data from the server and provides automated controls to lower energy costs.
- An integrated industry-standard Unified Extensible Firmware Interface (UEFI) enables improved setup, configuration, and updates, and simplifies error handling.
- Support for industry standard management protocols, IPMI 2.0, SNMP 3.0, Redfish REST API, serial console via IPMI
- An integrated hardware Trusted Platform Module (TPM) supporting TPM 2.0 enables advanced cryptographic functionality, such as digital signatures and remote attestation.
- Administrator and power-on passwords help protect from unauthorized access to the server.
- Supports AMD Secure Root-of-Trust, Secure Run and Secure Move features to minimize potential attacks and protect data as the OS is booted, as applications are run and as applications are migrated from server to server.
- Supports Secure Boot to ensure only a digitally signed operating system can be used.
- Industry-standard Advanced Encryption Standard (AES) NI support for faster, stronger encryption.
- Additional physical security features are a chassis intrusion switch and a lockable front bezel.

Energy efficiency

The following energy-efficiency features help save energy, reduce operational costs, and increase energy availability:

- Energy-efficient planar components help lower operational costs.
- High-efficiency power supplies with 80 PLUS Titanium certifications
- Low-voltage 1.1V DDR5 memory offers energy savings compared to 1.2V DDR4 DIMMs, an approximately 20% decrease in power consumption
- Solid-state drives (SSDs) consume as much as 80% less power than traditional spinning 2.5-inch HDDs.
- The server uses hexagonal ventilation holes, which can be grouped more densely than round holes, providing more efficient airflow through the system and thus keeping your system cooler.
- Optional Lenovo XClarity Energy Manager provides advanced data center power notification and analysis to help achieve lower heat output and reduced cooling needs.

Comparing the SR665 V3 to the SR665

The ThinkSystem SR665 V3 improves on the previous generation SR665, as summarized in the following table.

Table 1. Comparing the SR665 V3 to the SR665

Feature	SR665	SR665 V3	Benefits
Processor	<ul style="list-style-type: none"> • 2x 2nd or 3rd Gen AMD EPYC processors • Up to 64 cores • TDP ratings up to 280W • 64x PCIe 4.0 lanes per processor • 4x dedicated xGMI x16 interprocessor links 	<ul style="list-style-type: none"> • 2x 4th Gen AMD EPYC processors • Up to 128 cores • TDP ratings up to 360W • 64x PCIe 5.0 lanes per processor • 4x xGMI x16 interprocessor links, 1 of which can be used for an additional 16 PCIe 5.0 lanes 	<ul style="list-style-type: none"> • Significant increase in cores per processor • Increased performance • Consolidation of more apps on same number of servers, reducing costs • New PCIe 5.0 support means higher performance networking and NVMe storage • Additional 16 PCIe lanes using an xGMI link for PCIe
Memory	<ul style="list-style-type: none"> • DDR4 memory operating up to 2933 MHz • 8 channels per CPU • 32 DIMMs (16 per processor), 2 DIMMs per channel • Supports RDIMMs and 3DS RDIMMs • Up to 8TB of system memory 	<ul style="list-style-type: none"> • DDR5 memory operating up to 4800 MHz • 12 channels per CPU • 24 DIMMs (12 per processor), 1 DIMM per channel • Supports RDIMMs, 3DS RDIMMs and 9x4 RDIMMs • Up to 6TB of system memory 	<ul style="list-style-type: none"> • New DDR5 memory offers significant performance improvements over DDR4 • More memory channels means greater memory bandwidth • Support for lower-cost 9x4 DIMMs
Internal storage	<ul style="list-style-type: none"> • 20x 3.5" SAS/SATA/NVMe (12 front, 4 mid, 4 rear) • 40x 2.5" SAS/SATA/NVMe (24 front, 8 mid, 8 rear) • Up to 4x 3.5" or 8x 2.5" mid-chassis drive bays • Up to 4x 3.5" or 8x 2.5" rear drive bays • 2x Internal M.2 with optional RAID • 16x onboard NVMe ports • 2x rear 7mm hot swap SAS/SATA/NVMe; optional RAID 	<ul style="list-style-type: none"> • 20x 3.5" SAS/SATA/NVMe (12 front, 4 mid, 4 rear) • 40x 2.5" SAS/SATA/NVMe (24 front, 8 mid, 8 rear) • Up to 4x 3.5" or 8x 2.5" mid-chassis drive bays • Up to 4x 3.5" or 8x 2.5" rear drive bays • 2x Internal M.2 with optional RAID 1 (RAID support via a separate adapter) • 20x onboard NVMe ports • 2x rear 7mm hot swap SAS/SATA/NVMe (RAID support via a separate adapter) 	<ul style="list-style-type: none"> • Flexible storage offerings • Up to 32x NVMe drives for high-performance storage • 7mm hot swap drives as boot drives

Feature	SR665	SR665 V3	Benefits
RAID	<ul style="list-style-type: none"> 8-port and 16-port RAID adapters with up to 8GB flash Support for Lenovo and Broadcom adapters Support for PCIe or Internal cabled (CFF) form factor adapters Support for NVMe drives connected to 940 RAID adapters (Tri-Mode) Storage HBAs available PCIe 3.0 and PCIe 4.0 adapter choices 	<ul style="list-style-type: none"> 8-port and 16-port RAID adapters with up to 8GB flash Support for Lenovo and Broadcom adapters Support for PCIe or Internal cabled (CFF) form factor adapters Support for NVMe drives connected to 940 RAID adapters (Tri-Mode) Storage HBAs available PCIe 3.0 and PCIe 4.0 adapter choices with support for Gen 5 adapters when available 	<ul style="list-style-type: none"> Consistent RAID/HBA support Flexible config solution PCIe Gen 5 allows for greater storage performance
Networking	<ul style="list-style-type: none"> OCP 3.0 slot with PCIe Gen 4 x16 interface (rear of server) Additional PCIe adapters supported 1GbE dedicated Management port 	<ul style="list-style-type: none"> OCP 3.0 slot with PCIe Gen 5 x16 interface (rear or front of server) Additional PCIe adapters supported 1GbE dedicated Management port 	<ul style="list-style-type: none"> Improved performance with PCIe Gen 5 Optional front-accessible OCP slot
PCIe	<ul style="list-style-type: none"> Supports PCIe 4.0 Up to 8x PCIe slots (all full-height slots) Supports a RAID/HBA in CFF form factor (does not occupy a PCIe slot) Additional OCP 3.0 slot 	<ul style="list-style-type: none"> Supports PCIe 5.0 Up to 12x PCIe slots, front and rear Up to 10x PCIe slots at the rear (6x full height, 4x low-profile) or 8x PCIe slots (all full-height slots) Up to 9x slots can be PCIe 5.0 Supports a RAID/HBA in CFF form factor (does not occupy a PCIe slot) Additional OCP 3.0 slot Support for 3x front-accessible slots (2x FH PCIe + 1x OCP) with 16 drive bays Flexible xGMI interprocessor links allowing 1 link to be converted to two 16 PCIe 5.0 x16 connections 	<ul style="list-style-type: none"> More PCIe slots PCIe Gen 5 allows for greater I/O performance Flexible PCIe offerings Front-accessible slots available More PCIe connections for greater PCIe/NVMe support
GPU support	<ul style="list-style-type: none"> Supports up to 8x single-wide GPUs or up to 3x double-wide GPUs 	<ul style="list-style-type: none"> Supports up to 8x single-wide GPUs or up to 3x double-wide GPUs 	<ul style="list-style-type: none"> High performance GPU support

Feature	SR665	SR665 V3	Benefits
Management and security	<ul style="list-style-type: none"> ● XClarity Controller ● Support for full XClarity toolset including XClarity Administrator ● Platform Firmware Resiliency (PFR) hardware Root of Trust (RoT) ● Tamper Switch security solution (intrusion switch) 	<ul style="list-style-type: none"> ● Integrated XClarity Controller 2 ● Support for full XClarity toolset including XClarity Administrator ● Platform Firmware Resiliency (PFR) hardware Root of Trust (RoT) ● Tamper Switch security solution (intrusion switch) 	<ul style="list-style-type: none"> ● New XCC2 offers improved management capabilities ● Same system management tool with previous generation ● Silicon-level security solution
Power	<ul style="list-style-type: none"> ● Choice of 500W, 750W, 1100W, 1800W AC Hot Plug PSUs ● Available in Titanium and Platinum efficiency levels ● 1100W -48VDC Platinum general support ● 240V HVDC support for PRC customers ● Active-Standby mode 	<ul style="list-style-type: none"> ● Choice of 500W, 750W, 1100W, 1800W, 2400W, 2600W AC Hot Plug PSUs ● Available in Titanium and Platinum efficiency levels ● 1100W -48VDC Platinum general support ● 240V HVDC support for PRC customers ● Active-Standby mode 	<ul style="list-style-type: none"> ● Multiple PSU offerings to suit the configuration selected ● New ErP Lot 9-compliant offerings ● Support for Telco customers with -48V requirements

Components and connectors

The following figure shows the front of the server. The server supports either 2.5-inch or 3.5-inch hot-swap drives at the front, and configurations with 16x 2.5-inch drive bays optionally support 3 front-accessible PCIe slots.

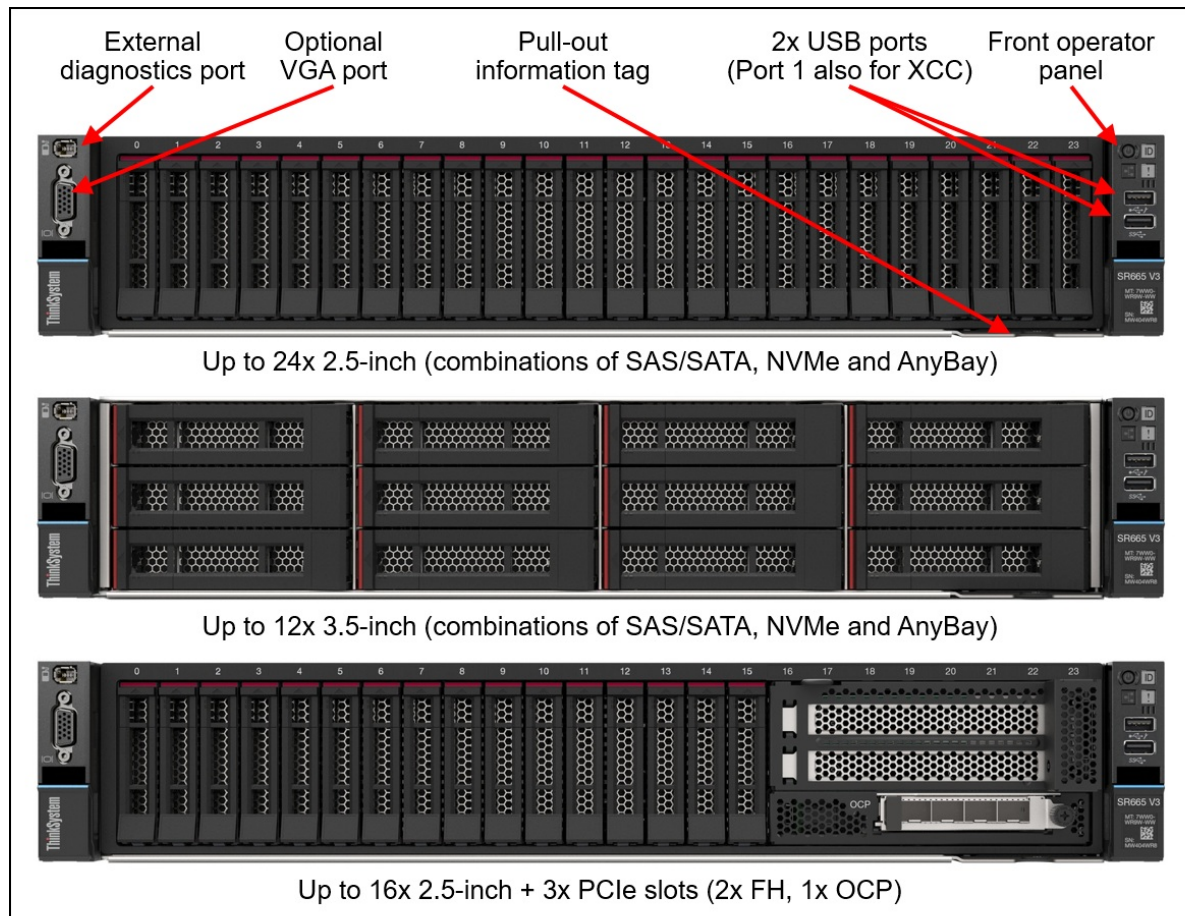

Figure 2. Front view of the ThinkSystem SR665 V3

For details on the front ports, including the optional front VGA port and front external diagnostic port, see the [Local management](#) section.

The following figure shows the components visible from the rear of the server. The figure shows one configuration, with eight full-height PCIe slots, however there are additional rear configurations which include 10 PCIe slots (6x full-height, 4x low-profile), or include 3.5-inch drive bays or 2.5-inch drive bays. The server also supports two rear-accessible 7mm hot-swap drive bays.

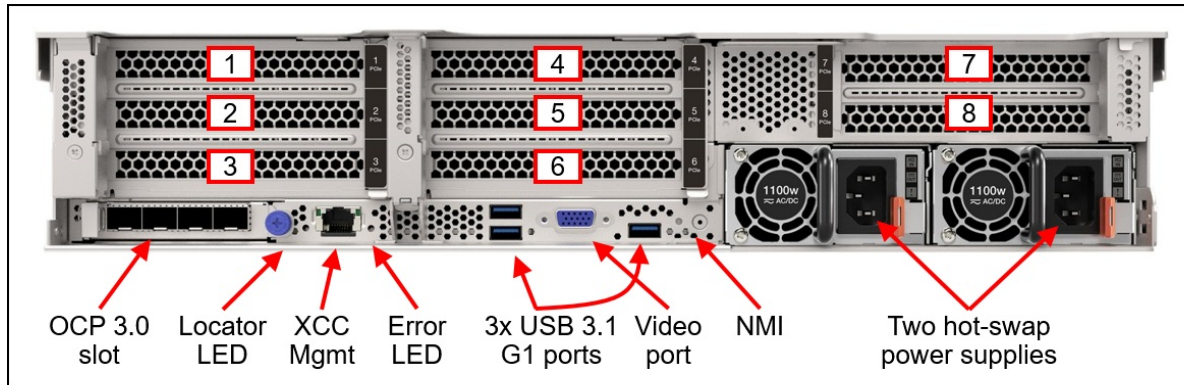

Figure 3. Rear view of the ThinkSystem SR665 V3 (configuration with eight full-height PCIe slots)

The following figure shows the locations of key components inside the server.

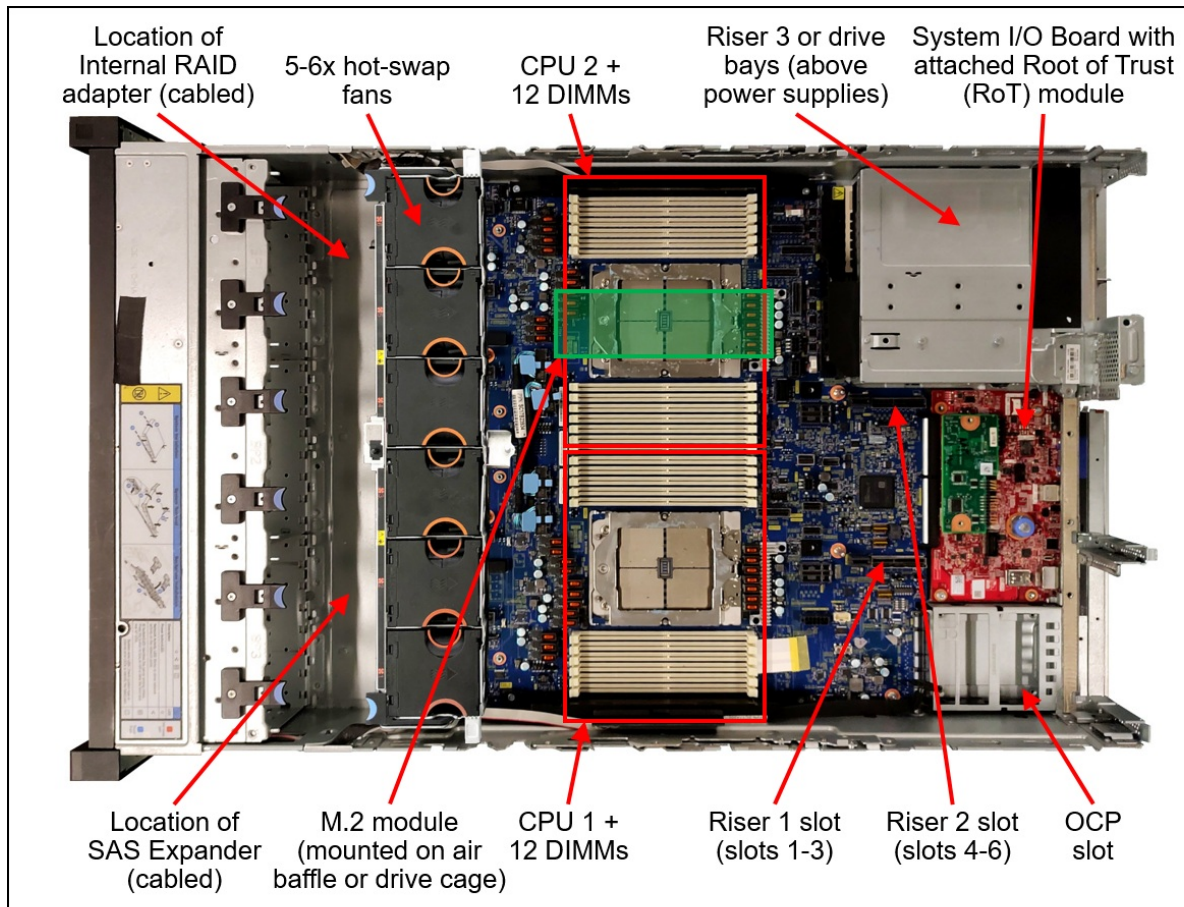

Figure 4. Internal view of the ThinkSystem SR665 V3

System architecture

The following figure shows the architectural block diagram of the SR665 V3, showing the major components and their connections.

Note that one of the xGMI links between the processors can be used instead as two PCIe 5.0 x16 connections. These PCIe connections can be used for additional NVMe drive support.

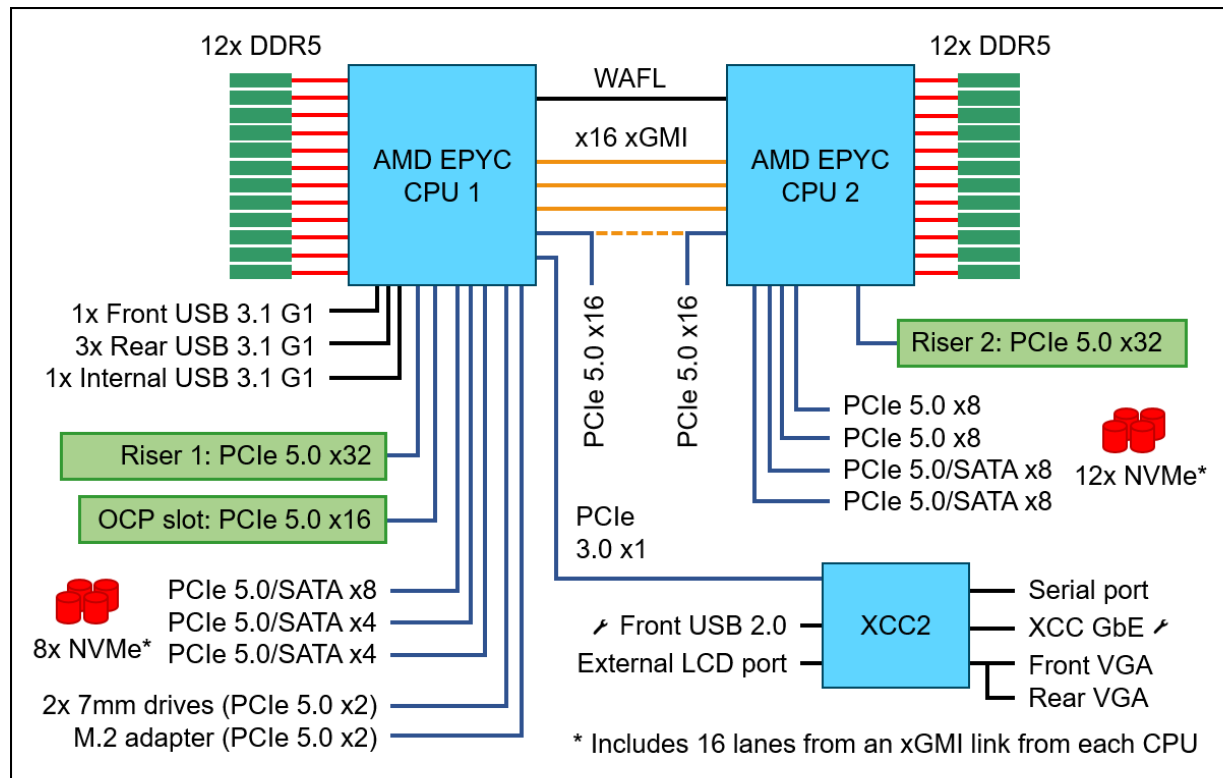

Figure 5. SR665 V3 system architectural block diagram

Standard specifications

The following table lists the standard specifications.

Table 2. Standard specifications

Components	Specification
Machine types	7D9B - 1 year warranty 7D9A - 3 year warranty
Form factor	2U rack.
Processor	One or two AMD EPYC 9004 Series processors (formerly codenamed "Genoa"). Supports processors up to 128 cores, core speeds of up to 4.1 GHz, and TDP ratings of up to 360W. Supports PCIe 5.0 for high performance I/O.
Chipset	Not applicable (platform controller hub functions are integrated into the processor)
Memory	24 DIMM slots with two processors (12 DIMM slots per processor). Each processor has 12 memory channels, with 1 DIMM per channel (DPC). Lenovo TruDDR5 RDIMMs, 3DS RDIMMs, and 9x4 RDIMMs are supported, up to 4800 MHz
Memory maximum	Up to 6TB with 24x 256GB 3DS RDIMMs

Components	Specification
Persistent memory	Not supported.
Memory protection	ECC, SDDC, Patrol/Demand Scrubbing, Bounded Fault, DRAM Address Command Parity with Replay, DRAM Uncorrected ECC Error Retry, On-die ECC, ECC Error Check and Scrub (ECS), Post Package Repair
Disk drive bays	<p>Up to 20x 3.5-inch or 40x 2.5-inch hot-swap drive bays:</p> <ul style="list-style-type: none"> • Front bays can be 3.5-inch (8 or 12 bays) or 2.5-inch (8, 16 or 24 bays) • Middle bays can be 3.5-inch (4 bays) or 2.5-inch (8 bays) • Rear bays can be 3.5-inch (2 or 4 bays) or 2.5-inch (4 or 8 bays) • Combinations of SAS/SATA, NVMe, or AnyBay (supporting SAS, SATA or NVMe) are available <p>The server also supports these drives for OS boot or drive storage:</p> <ul style="list-style-type: none"> • Two 7mm drives at the rear of the server (optional RAID) • Internal M.2 module supporting up to two M.2 drives (optional RAID) <p>See Storage configurations for details.</p>
Maximum internal storage	<ul style="list-style-type: none"> • 2.5-inch drives: <ul style="list-style-type: none"> ◦ 1228.8TB using 40x 30.72TB 2.5-inch SAS/SATA SSDs ◦ 491.52TB using 32x 15.36TB 2.5-inch NVMe SSDs ◦ 96TB using 40x 2.4TB 2.5-inch HDDs • 3.5-inch drives: <ul style="list-style-type: none"> ◦ 440TB using 20x 22TB 3.5-inch HDDs ◦ 307.2TB using 20x 15.36TB 3.5-inch SAS/SATA SSDs ◦ 153.6TB using 12x 12.8TB 3.5-inch NVMe SSDs
Storage controller	<ul style="list-style-type: none"> • Up to 20x Onboard SATA ports (non-RAID) • Up to 20x Onboard NVMe ports (non-RAID) • NVMe Retimer Adapter (PCIe 4.0 or PCIe 5.0) • 12 Gb SAS/SATA RAID adapters <ul style="list-style-type: none"> ◦ 8, 16 or 32 ports ◦ Up to 8GB flash-backed cache ◦ PCIe 4.0 or PCIe 3.0 host interface • 12 Gb SAS/SATA HBA (non-RAID) <ul style="list-style-type: none"> ◦ 8-port and 16-port ◦ PCIe 4.0 or PCIe 3.0 host interface
Optical drive bays	No internal optical drive
Tape drive bays	No internal backup drive
Network interfaces	Dedicated OCP 3.0 SFF slot with PCIe 5.0 x16 host interface, either at the rear of the server (rear-accessible) for the front of the server (front-accessible). Supports a variety of 2-port and 4-port adapters with 1GbE, 10GbE and 25GbE network connectivity. One port can optionally be shared with the XClarity Controller 2 (XCC2) management processor for Wake-on-LAN and NC-SI support. Additional PCIe network adapters supported in PCIe slots.

Components	Specification
PCI Expansion slots	<p>Up to 12x PCIe slots (10x rear, 2x front), plus a slot dedicated to an OCP 3.0 adapter. 2.5-inch drive configurations also support an additional internal bay for a cabled RAID adapter or HBA.</p> <p><i>Rear:</i> Up to 10x PCIe slots, plus a slot dedicated to the OCP adapter. Slot are either PCIe 5.0 or 4.0 depending on riser selection and rear drive bay selection. The use of some slots requires two processors.</p> <p>Slots are configured using three riser cards. Riser 1 (slots 1-3) and Riser 2 (slots 4-6) are installed in slots in the system board, Riser 3 (slots 7-8) and Riser 4 (9-10) are cabled to ports on the system board. A variety of riser cards are available. See the I/O expansion for details.</p> <p><i>Front:</i> The server also supports slots at the front of the server (configurations with up to 16 drive bays): 2x PCIe x16 full-height half-length slots, plus 1x OCP 3.0 slot</p> <p><i>Internal:</i> For 2.5-inch front drive configurations, the server supports the installation of a RAID adapter or HBA in a dedicated area that does not consume any of the PCIe slots.</p>
Ports	<p>Front: 1x USB 3.2 G1 (5 Gb/s) port, 1x USB 2.0 port (also for XCC local management), External diagnostics port, optional VGA port.</p> <p>Rear: 3x USB 3.2 G1 (5 Gb/s) ports, 1x VGA video port, 1x RJ-45 1GbE systems management port for XCC remote management. Optional 2nd XCC remote management port (installs in OCP slot). Optional DB-9 COM serial port (installs in slot 3).</p> <p>Internal: 1x USB 3.2 G1 (5 Gb/s) connector for operating system or license key purposes.</p>
Cooling	Up to 6x N+1 redundant hot swap 60 mm fans, configuration dependent. One fan integrated in each power supply.
Power supply	Up to two hot-swap redundant AC power supplies, 80 PLUS Platinum or 80 PLUS Titanium certification. 750 W, 1100 W, 1800 W, 2400 W, and 2600 W AC, supporting 220 V AC. 750 W and 1100 W options also support 110V input supply. In China only, all power supply options support 240 V DC. Also available is a 1100W power supply with a -48V DC input.
Video	Embedded video graphics with 16 MB memory with 2D hardware accelerator, integrated into the XClarity Controller. Maximum resolution is 1920x1200 32bpp at 60Hz.
Hot-swap parts	Drives, power supplies, and fans.
Systems management	Operator panel with status LEDs. Optional External Diagnostics Handset with LCD display. Models with 16x 2.5-inch front drive bays can optionally support an Integrated Diagnostics Panel. XClarity Controller 2 (XCC2) embedded management based on the ASPEED AST2600 baseboard management controller (BMC). Dedicated rear Ethernet port for XCC2 remote access for management. Optional 2nd redundant XCC2 remote port supported, installs in the OCP slot. XClarity Administrator for centralized infrastructure management, XClarity Integrator plugins, and XClarity Energy Manager centralized server power management. Optional XCC Platinum to enable remote control functions and other features.
Security features	Chassis intrusion switch, Power-on password, administrator's password, Root of Trust module supporting TPM 2.0 and Platform Firmware Resiliency (PFR). Optional lockable front security bezel.
Operating systems supported	Microsoft Windows Server, Microsoft Windows 10 & 11, Red Hat Enterprise Linux, SUSE Linux Enterprise Server, VMware ESXi, Ubuntu Server. See the Operating system support section for specifics.
Limited warranty	Three-year or one-year (model dependent) customer-replaceable unit and onsite limited warranty with 9x5 next business day (NBD).
Service and support	Optional service upgrades are available through Lenovo Services: 4-hour or 2-hour response time, 6-hour fix time, 1-year or 2-year warranty extension, software support for Lenovo hardware and some third-party applications.

Components	Specification
Dimensions	Width: 445 mm (17.5 in.), height: 87 mm (3.4 in.), depth: 766 mm (30.1 in.). See Physical and electrical specifications for details.
Weight	Maximum: 38.8 kg (85.5 lb)

Models

ThinkSystem SR665 V3 models can be configured by using the [Lenovo Data Center Solution Configurator \(DCSC\)](#).

Topics in this section:

- [CTO models](#)
- [CTO models for Windows 10 and Windows 11](#)
- [Base feature codes](#)
- [Preconfigured models](#)

CTO models

ThinkSystem SR665 V3 models can be configured by using the [Lenovo Data Center Solution Configurator \(DCSC\)](#).

Configure-to-order (CTO) models are used to create models with factory-integrated server customizations. For CTO models, two base CTO models are available for the SR665 V3 as listed in the following table, CTO1WW and CTOLWW:

- The CTO1WW base CTO model is for general business and is selectable by choosing **General Purpose** mode in DCSC.
- The CTOLWW base model is intended for High Performance Computing (HPC) and Artificial Intelligence (AI) configurations and solutions, including configurations for Lenovo Scalable Infrastructure (LeSI), and is enabled using either the **HPC & AI LeSI Solutions** mode or **HPC & AI Hardware** mode in DCSC. CTOLWW configurations can also be built using [System x and Cluster Solutions Configurator \(x-config\)](#).

Preconfigured server models may also be available for the SR665 V3, however these are region-specific; that is, each region may define their own server models, and not all server models are available in every region.

The following table lists the base CTO models of the ThinkSystem SR665 V3 server.

Table 3. Base CTO models

Machine Type/Model General purpose	Machine Type/Model for HPC and AI	Description
7D9ACTO1WW	7D9ACTOLWW	ThinkSystem SR665 V3 – 3-year Warranty
7D9BCTO1WW	7D9BCTOLWW	ThinkSystem SR665 V3 – 1-year Warranty

CTO models for Windows 10 and Windows 11

The SR665 V3 can run Windows 10 and Windows 11, however only a subset of adapters and drives can be installed. For ease of configuration, the following Base CTO models have been announced to assist building a configuration that can be used with the client operating systems. For more information, see the [Windows 10 and Windows 11](#) section.

Table 4. Base CTO models for SR665 V3 with Windows 10 and Windows 11

Machine Type/Model	Description
7D9ACTO2WW	ThinkSystem SR665 V3 Workstation - 3 year Warranty
7D9BCTO2WW	ThinkSystem SR665 V3 Workstation - 1 year Warranty

Base feature codes

Models of the SR665 V3 are defined based on whether the server has 2.5-inch drive bays at the front (called the 2.5-inch chassis) or whether it has 3.5-inch drive bays at the front (called the 3.5-inch chassis). For models, the feature codes for these chassis bases are as listed in the following table.

Table 5. Chassis base feature codes

Feature code	Description
BLKJ	ThinkSystem V3 2U 12x3.5" Chassis
BLKK	ThinkSystem V3 2U 24x2.5" Chassis

Preconfigured models

The following tables list the available preconfigured models, grouped by region.

- [Models for Asia Pacific region](#)
- [Models for Australia and New Zealand](#)
- [Models for EMEA region](#)
- [Models for India](#)

Refer to the Specifications section for information about standard features of the server.

Common to all models:

- Power supplies are Platinum unless otherwise stated
- All models include a Toolless Slide Rail Kit

Models for Asia Pacific region

The following table lists the models for the Asia Pacific region: Australia, Bangladesh, Brunei, Hong Kong, India, Japan, Korea, Sri Lanka, Malaysia, New Zealand, Philippines, Singapore, Thailand, Taiwan, Vietnam

Table 6. Models for Asia Pacific markets

Model	AMD EPYC processor†	Memory	RAID	Drive bays	OCP	Slots	Power supply	Fans	Front VGA	Front diag	XCC2	Intru switch
Standard models with a 3-year warranty (machine type 7D9A)												
7D9AA01JAP	1x 9124 16C 200W 3.0G	1x16GB	9350-8i	8x 2.5" SAS Open bay	4x1G I350	3 (x16, x8, x8) Gen4	1x750W	5x Perf	Opt	Opt	Std	Opt
7D9AA01LAP	1x 9224 24C 200W 2.5G	1x16GB	9350-8i	12x 3.5" SAS w/Expander Open bay	4x1G I350	3 (x16, x8, x8) Gen4	1x750W	5x Perf	Opt	Opt	Std	Opt

† Processor description: Processor model, number of cores, thermal design power (TDP), core frequency

Models for Australia and New Zealand

AP models: Customers in Australia and New Zealand also have access to the [Asia Pacific region](#) models.

Common to all Australia and New Zealand models:

- All models include a Toolless Slide Rail Kit and Cable Management Arm

Table 7. Models for Australia and New Zealand

Model	AMD EPYC processor†	Memory	RAID	Drive bays	OCP	Slots	Power supply	Fans	Front VGA	Front diag	XCC2	Intru switch
TopSeller models with a 3-year warranty (machine type 7D9A)												
7D9AA01EAU	1x 9124 16C 200W 3.0G	1x16GB	5350-8i	8x 2.5" SAS Open bay	Open	3 (x16, x8, x8) Gen4	1x750W	5x Perf	Yes	Opt	Std	Opt
7D9AA01FAU	1x 9124 16C 200W 3.0G	1x16GB	9350-8i	8x 2.5" SAS Open bay	Open	3 (x16, x8, x8) Gen4	1x750W	5x Perf	Yes	Opt	Std	Opt
7D9AA01GAU	1x 9224 24C 200W 2.5G	1x32GB 2Rx8	9350-8i	8x 2.5" SAS Open bay	Open	3 (x16, x8, x8) Gen4	1x750W	5x Perf	Yes	Opt	Std	Opt

† Processor description: Processor model, number of cores, thermal design power (TDP), core frequency

Models for EMEA region

Table 8. Models for EMEA region

Model	AMD EPYC processor†	Memory	RAID	Drive bays	OCF	Slots	Power supply	Fans	Front VGA	Front diag	XCC2	Intru switch
Standard models with a 3-year warranty (machine type 7D9A)												
7D9AA010EA	1x 9124 16C 200W 3.0G	1x32GB 2Rx8	9350-8i 2GB Int	8x 2.5" SAS Open bay	Open	3 (x16, x8, x8) Gen4	1x1100W Titanium	5x Perf	Opt	Yes	Plat	Opt
7D9AA01TEA	1x 9124 16C 200W 3.0G	1x32GB 1Rx4	Option	Option 2.5" Open bay	Open	Open	1x1100W Titanium	5x Std	Opt	Opt	Plat	Opt
7D9AA025EA	1x 9124 16C 200W 3.0G	1x32GB 1Rx4	Option	Option 2.5" Open bay	Open	Open	1x1100W Titanium	5x Std	Opt	Opt	Plat	Opt
7D9AA01QEA	1x 9174F 16C 320W 4.1G	1x32GB 1Rx4	Option	Option 2.5" Open bay	Open	Open	1x1800W Titanium	5x Perf	Opt	Opt	Plat	Opt
7D9AA026EA	1x 9174F 16C 320W 4.1G	1x32GB 1Rx4	Option	Option 2.5" Open bay	Open	Open	1x1800W Titanium	5x Perf	Opt	Opt	Plat	Opt
7D9AA01PEA	1x 9254 24C 200W 2.9G	1x64GB	Option	Option 2.5" Open bay	Open	Open	1x1100W Titanium	5x Std	Opt	Opt	Plat	Opt
7D9AA01ZEA	1x 9254 24C 200W 2.9G	1x32GB 1Rx4	Option	Option 2.5" Open bay	Open	Open	1x1100W Titanium	5x Std	Opt	Opt	Plat	Opt
7D9AA01REA	1x 9274F 24C 320W 4.05G	1x64GB	Option	Option 2.5" Open bay	Open	Open	1x1800W Titanium	5x Perf	Opt	Opt	Plat	Opt
7D9AA01XEA	1x 9274F 24C 320W 4.05G	1x32GB 1Rx4	Option	Option 2.5" Open bay	Open	Open	1x1800W Titanium	5x Perf	Opt	Opt	Plat	Opt
7D9AA00ZEA	1x 9334 32C 210W 2.7G	1x32GB 2Rx8	9350-8i 2GB Int	8x 2.5" SAS Open bay	Open	3 (x16, x8, x8) Gen4	1x1100W Titanium	5x Perf	Opt	Yes	Plat	Opt
7D9AA00XEA	1x 9354 32C 280W 3.25G	1x64GB	9350-8i 2GB Int	8x 2.5" SAS Open bay	Open	3 (x16, x8, x8) Gen4	1x1100W Titanium	5x Perf	Opt	Yes	Plat	Opt
7D9AA01SEA	1x 9354 32C 280W 3.25G	1x64GB	Option	Option 2.5" Open bay	Open	Open	1x1800W Titanium	5x Perf	Opt	Opt	Plat	Opt
7D9AA01YEA	1x 9354 32C 280W 3.25G	1x32GB 1Rx4	Option	Option 2.5" Open bay	Open	Open	1x1800W Titanium	5x Perf	Opt	Opt	Plat	Opt
7D9AA00YEA	1x 9534 64C 280W 2.45G	1x64GB	9350-8i 2GB Int	8x 2.5" SAS Open bay	Open	3 (x16, x8, x8) Gen4	1x1100W Titanium	5x Perf	Opt	Yes	Plat	Opt
7D9AA00WEA	1x 9554 64C 360W 3.1G	2x64GB	9350-8i 2GB Int	8x 2.5" SAS Open bay	Open	3 (x16, x8, x8) Gen4	1x1800W Titanium	5x Perf	Opt	Yes	Plat	Opt

† Processor description: Processor model, number of cores, thermal design power (TDP), core frequency

Models for India

Common to all India models:

- All models include a Toolless Slide Rail Kit with Cable Management Arm (CMA)

AP models: Customers in India also have access to the [Asia Pacific region](#) models.

Table 9. Models for India

Model	AMD EPYC processor†	Memory	RAID	Drive bays	OCP	Slots	Power supply	Fans	Front VGA	Front diag	XCC2	Intru switch
TopSeller models with a 3-year warranty (machine type 7D9A)												
7D9AA02BSG	1x 9124 16C 200W 3.0G	1x32GB 1Rx4	Option	16x 2.5" Any Open bay	2x10GT 57416	3 (x16, x8, x8) Gen4	2x 1100W	5x Perf	Opt	Opt	Std	Opt

† Processor description: Processor model, number of cores, thermal design power (TDP), core frequency

Processors

The SR665 V3 supports processors in the fourth-generation AMD EPYC family of processors. The server supports one or two processors.

Topics in this section:

- [Processor options](#)
- [Processor features](#)
- [One-processor configurations](#)
- [Thermal requirements by processor](#)
- [UEFI operating modes](#)

Processor options

The table below lists the AMD processors that are currently supported by the SR665 V3.

All supported processors have the following characteristics:

- Fourth-generation AMD EPYC processors (formerly codenamed "Genoa")
- Also support
- 12 DDR5 memory channels
- 128 PCIe 5.0 I/O lanes, 64 lanes available for PCIe and NVMe devices

The SR665 V3 also supports the new 4th Gen AMD EPYC processors with "Zen 4c" architecture (formerly codenamed "Bergamo"). These processors have higher core counts, up to 128 cores, targeted at cloud native applications that are designed to exploit the scale, elasticity, resiliency, and flexibility of private & public clouds.

Table 10. SR665 V3 processor support

Part number*	Feature code	SKU	Description	Quantity supported*
4th Gen AMD EPYC processors ("Genoa")				
4XG7A85822	BREE	9124	ThinkSystem SR665 V3 AMD EPYC 9124 16C 200W 3.0GHz Processor w/o Fan	1 or 2
4XG7A85827	BREJ	9174F	ThinkSystem SR665 V3 AMD EPYC 9174F 16C 320W 4.1GHz Processor w/o Fan	1 or 2
4XG7A85819	BREH	9224	ThinkSystem SR665 V3 AMD EPYC 9224 24C 200W 2.5GHz Processor w/o Fan	1 or 2
4XG7A85821	BRED	9254	ThinkSystem SR665 V3 AMD EPYC 9254 24C 200W 2.9GHz Processor w/o Fan	1 or 2
4XG7A85826	BREF	9274F	ThinkSystem SR665 V3 AMD EPYC 9274F 24C 320W 4.05GHz Processor w/o Fan	1 or 2
4XG7A85820	BREC	9334	ThinkSystem SR665 V3 AMD EPYC 9334 32C 210W 2.7GHz Processor w/o Fan	1 or 2
4XG7A85824	BR30	9354	ThinkSystem SR665 V3 AMD EPYC 9354 32C 280W 3.25GHz Processor w/o Fan	1 or 2
None	BREG	9354P	ThinkSystem AMD EPYC 9354P 32C 280W 3.25GHz Processor	1
4XG7A85825	BR32	9374F	ThinkSystem SR665 V3 AMD EPYC 9374F 32C 320W 3.85GHz Processor w/o Fan	1 or 2
4XG7A85818	BREB	9454	ThinkSystem SR665 V3 AMD EPYC 9454 48C 290W 2.75GHz Processor w/o Fan	1 or 2
None	BREM	9454P	ThinkSystem AMD EPYC 9454P 48C 290W 2.75GHz Processor	1
4XG7A85823	BR31	9474F	ThinkSystem SR665 V3 AMD EPYC 9474F 48C 360W 3.6GHz Processor w/o Fan	1 or 2
4XG7A85817	BREA	9534	ThinkSystem SR665 V3 AMD EPYC 9534 64C 280W 2.45GHz Processor w/o Fan	1 or 2
4XG7A85816	BPVJ	9554	ThinkSystem SR665 V3 AMD EPYC 9554 64C 360W 3.1GHz Processor w/o Fan	1 or 2
None	BREL	9554P	ThinkSystem AMD EPYC 9554P 64C 360W 3.1GHz Processor	1
4XG7A85828	BR2Z	9634	ThinkSystem SR665 V3 AMD EPYC 9634 84C 290W 2.25GHz Processor w/o Fan	1 or 2
4XG7A85815	BPVK	9654	ThinkSystem SR665 V3 AMD EPYC 9654 96C 360W 2.4GHz Processor w/o Fan	1 or 2
None	BREK	9654P	ThinkSystem AMD EPYC 9654P 96C 360W 2.4GHz Processor	1
4th Gen AMD EPYC processors with Zen 4c architecture ("Bergamo")				
CTO only	BW9S	9734	ThinkSystem AMD EPYC 9734 112C 340W 2.2GHz Processor	1 or 2
CTO only	BW9T	9754	ThinkSystem AMD EPYC 9754 128C 360W 2.25GHz Processor	1 or 2

* Processors with a P suffix are single-socket capable processors and are only available in configure-to-order builds or in preconfigured models. Not available as option part numbers.

Configuration notes:

- Processor options include a heatsink but do not include a system fan

Processor features

The following table lists the features of the supported processors.

Table 11. Processor specifications

EPYC model**	Cores / Threads	Base Frequency	Max Boost Frequency†	L3 Cache	Memory channels	Memory bus	TDP
4th Gen AMD EPYC processors ("Genoa")							
9124	16 / 32	3.0 GHz	3.7 GHz	64 MB	12	4800 MHz	200W
9174F	16 / 32	4.1 GHz	4.4 GHz	256 MB	12	4800 MHz	320W
9224	24 / 48	2.5 GHz	3.7 GHz	64 MB	12	4800 MHz	200W
9254	24 / 48	2.9 GHz	4.15 GHz	128 MB	12	4800 MHz	200W
9274F	24 / 48	4.05 GHz	4.3 GHz	256 MB	12	4800 MHz	320W
9334	32 / 64	2.7 GHz	3.9 GHz	128 MB	12	4800 MHz	210W
9354	32 / 64	3.25 GHz	3.8 GHz	256 MB	12	4800 MHz	280W
9354P	32 / 64	3.25 GHz	3.8 GHz	256 MB	12	4800 MHz	280W
9374F	32 / 64	3.85 GHz	4.3 GHz	256 MB	12	4800 MHz	320W
9454	48 / 96	2.75 GHz	3.8 GHz	256 MB	12	4800 MHz	290W
9454P	48 / 96	2.75 GHz	3.8 GHz	256 MB	12	4800 MHz	290W
9474F	48 / 96	3.6 GHz	4.1 GHz	256 MB	12	4800 MHz	360W
9534	64 / 128	2.45 GHz	3.7 GHz	256 MB	12	4800 MHz	280W
9554	64 / 128	3.1 GHz	3.75 GHz	256 MB	12	4800 MHz	360W
9554P	64 / 128	3.1 GHz	3.75 GHz	256 MB	12	4800 MHz	360W
9634	84 / 168	2.25 GHz	3.7 GHz	384 MB	12	4800 MHz	290W
9654	96 / 192	2.4 GHz	3.7 GHz	384 MB	12	4800 MHz	360W
9654P	96 / 192	2.4 GHz	3.7 GHz	384 MB	12	4800 MHz	360W
4th Gen AMD EPYC processors with Zen 4c architecture ("Bergamo")							
9734	112 / 224	2.2 GHz	3.0 GHz	256 MB	12	4800 MHz	340W
9754	128 / 256	2.25 GHz	3.2 GHz	256 MB	12	4800 MHz	360W

† The maximum single-core frequency that the processor is capable of operating

** Processors with a P suffix are single-socket capable processors

One-processor configurations

The SR665 V3 can be used with only one processor installed. Most core functions of the server (including the XClarity Controller) are connected to processor 1 as shown in the [System architecture](#) section.

With only one processor, the server has the following capabilities:

- 12 memory DIMMs
- Slot 1-3 are available; Slot 4-8 are not available
- 16 onboard SATA connections
- 8 onboard NVMe connections

Drive support and controller support is as listed in the [Storage configurations](#) section - see the rows for 1 processor installed in the tables.

Thermal requirements by processor

In the SR665 V3, processors either use a standard heatsink or a performance heatsink depending on the TDP of the processor. Performance heatsinks include two satellite heatsinks that connect to the main heatsink via liquid filled copper tubes.

For details regarding supported combinations of processors, front drive bays, GPUs, and fans, see the Thermal Rules page of the User Guide:

https://pubs.lenovo.com/sr665-v3/thermal_rules

Additional ambient temperature restrictions may apply. See the [Operating environment](#) section for details.

UEFI operating modes

The SR665 V3 offers preset operating modes that affect energy consumption and performance. These modes are a collection of predefined low-level UEFI settings that simplify the task of tuning the server to suit your business and workload requirements.

The following table lists the feature codes that allow you to specify the mode you wish to preset in the factory for CTO orders.

Table 12. UEFI operating mode presets in DCSC

Feature code	Description
BFYA	Operating mode selection for: "Maximum Efficiency Mode"
BFYB	Operating mode selection for: "Maximum Performance Mode"

The preset modes for the SR665 V3 are as follows:

- **Maximum Efficiency Mode** (feature BFYA): Maximizes performance/watt efficiency while maintaining reasonable performance
- **Maximum Performance Mode** (feature BFYB): Achieves maximum performance but with higher power consumption and lower energy efficiency.

For details about these preset modes, and all other performance and power efficiency UEFI settings offered in the SR665 V3, see the paper "Tuning UEFI Settings for Performance and Energy Efficiency on AMD Processor-Based ThinkSystem Servers", available from <https://lenovopress.lenovo.com/lp1267>.

Memory options

The SR665 V3 uses Lenovo TruDDR5 memory operating at up to 4800 MHz. The server supports up to 24 DIMMs with 2 processors. The processors have 12 memory channels and support 1 DIMM per channel. The server supports up to 6TB of memory using 24x 256GB 3DS RDIMMs and two processors.

The following table lists the memory options that are available for the server.

Lenovo TruDDR5 memory uses the highest quality components that are sourced from Tier 1 DRAM suppliers and only memory that meets the strict requirements of Lenovo is selected. It is compatibility tested and tuned to maximize performance and reliability. From a service and support standpoint, Lenovo TruDDR5 memory automatically assumes the system warranty, and Lenovo provides service and support worldwide.

Table 13. Memory options

Part number	Feature code	Description
9x4 RDIMMs		
4X77A81439	BQ3E	ThinkSystem 32GB TruDDR5 4800MHz (1Rx4) 9x4 RDIMM-A
4X77A81442	BQ36	ThinkSystem 64GB TruDDR5 4800MHz (2Rx4) 9x4 RDIMM-A
10x4 RDIMMs		
4X77A81438	BQ39	ThinkSystem 32GB TruDDR5 4800MHz (1Rx4) 10x4 RDIMM-A
4X77A81441	BQ3D	ThinkSystem 64GB TruDDR5 4800MHz (2Rx4) 10x4 RDIMM-A
4X77A81448	BUVV	ThinkSystem 96GB TruDDR5 4800MHz (2Rx4) 10x4 RDIMM-A
x8 RDIMMs		
4X77A81437	BQ3C	ThinkSystem 16GB TruDDR5 4800MHz (1Rx8) RDIMM-A
4X77A81440	BQ37	ThinkSystem 32GB TruDDR5 4800MHz (2Rx8) RDIMM-A
10x4 3DS RDIMMs		
4X77A81443	BQ3A	ThinkSystem 128GB TruDDR5 4800MHz (4Rx4) 3DS RDIMM-A v2
CTO only	BYEE	ThinkSystem 128GB TruDDR5 4800MHz (4Rx4) 3DS RDIMM-A v1
4X77A81444	BQ3B	ThinkSystem 256GB TruDDR5 4800MHz (8Rx4) 3DS RDIMM-A

9x4 RDIMMs (also known as Optimized or EC4 RDIMMs) are a new lower-cost DDR5 memory option supported in ThinkSystem V3 servers. 9x4 DIMMs offer the same performance as standard RDIMMs (known as 10x4 or EC8 modules), however they support lower fault-tolerance characteristics. Standard RDIMMs and 3DS RDIMMs support two 40-bit subchannels (that is, a total of 80 bits), whereas 9x4 RDIMMs support two 36-bit subchannels (a total of 72 bits). The extra bits in the subchannels allow standard RDIMMs and 3DS RDIMMs to support Single Device Data Correction (SDDC), however 9x4 RDIMMs do not support SDDC. Note, however, that all DDR5 DIMMs, including 9x4 RDIMMs, support Bounded Fault correction, which enables the server to correct most common types of DRAM failures.

For more information on DDR5 memory, see the Lenovo Press paper, *Introduction to DDR5 Memory*, available from <https://lenovopress.com/lp1618>.

The following rules apply when selecting the memory configuration:

- The SR665 V3 supports quantities 1, 2, 4, 6, 8, 10, 12 DIMMs per processor; other quantities not supported
- The server supports four types of DIMMs: 9x4 RDIMMs, 10x4 RDIMMs, x8 RDIMMs and 3DS RDIMMs; UDIMMs and LRDIMMs are not supported
- Mixing of DIMM types is not supported (for example, 9x4 DIMMs with 10x4 RDIMMs)
- Mixing of 128GB 3DS RDIMMs and 256GB 3DS RDIMMs is not supported
- Mixing x4 and x8 DIMMs is not supported
- Mixing of DIMM rank counts is supported. Follow the required installation order installing the DIMMs with the higher rank counts first.
- Mixing of DIMM capacities is supported, however only two different capacities are supported across all channels of the processor (eg 16GB and 32GB). Follow the required installation order installing the larger DIMMs first.
- The use of the 128GB 3D RDIMM feature BYEE has the following requirements for thermal reasons:
 - If CPU TDP > 240W, the combination of GPUs and 24x 2.5-inch drive bays is not supported
 - Additional ambient temperature requirements - see https://pubs.lenovo.com/sr665-v3/thermal_rules for information

Note: Memory mirroring and memory rank sparing are not supported.

For best performance, consider the following:

- Ensure the memory installed is at least the same speed as the memory bus of the selected processor.
- Populate all 12 memory channels with identical DIMMs (same Lenovo part number)

The following memory protection technologies are supported:

- ECC detection/correction
- Bounded Fault detection/correction
- SDDC (for x4-based memory DIMMs; look for "x4" in the DIMM description. Not supported with 9x4 RDIMMs)
- Patrol/Demand Scrubbing
- DRAM Address Command Parity with Replay
- DRAM Uncorrected ECC Error Retry
- On-die ECC
- ECC Error Check and Scrub (ECS)
- Post Package Repair

Internal storage

The SR665 V3 has three drive bay zones and supports up to 20x 3.5-inch or 40x 2.5-inch hot-swap drive bays or a combination of drive bays, depending on the selected chassis and backplane configuration. The server also supports configurations without any drive bays if desired.

The three drive bay zones are as follows:

- Front:
 - Up to 12x 3.5-inch hot-swap bays, or
 - Up to 24x 2.5-inch hot-swap bays
- Middle:
 - 4x 3.5-inch hot-swap bays, or
 - 8x 2.5-inch hot-swap bays
- Rear:
 - Up to 4x 3.5-inch hot-swap bays, or
 - Up to 8x 2.5-inch hot-swap bays
 - Also supports 2x 7mm hot-swap drives bays

All drives are hot-swap and are accessible from the front, from the rear, or from drive bays that are located in the middle of the server (accessible when you remove the top cover of the server).

The server also supports one or two M.2 drives, installed in an M.2 adapter internal to the server.

In this section:

- [NVMe drive support](#)
- [Front drive bays](#)
- [Mid drive bays](#)
- [Rear drive bays](#)
- [Storage configurations](#)
- [Field upgrades](#)
- [RAID flash power module \(supercap\) support](#)
- [7mm drives](#)
- [M.2 drives](#)
- [SED encryption key management with ISKLM](#)

NVMe drive support

The SR665 V3 supports NVMe drives to maximize storage performance.

- Up to 32 NVMe drives in a 2.5-inch drive configuration, without oversubscription (that is, each x4 drive has a dedicated x4 (4 lanes) connection to the processor, either direct to the processor or via a retimer adapter)
 - Up to 24 installed in front bays
 - Up to 32 installed in front and mid bays
- Up to 8 NVMe drives in a 3.5-inch drive configuration, without oversubscription
 - All installed in mid bays

Riser 3 support: The use of the onboard NVMe ports is mutually exclusive with Riser 3, as these use the same PCIe connectors. See the [System architecture](#) section.

The specifics of these configurations are covered in the [Storage configurations](#) section. The tables in those sections indicate the number of NVMe drives in each configuration.

In addition, the SR665 V3 supports two 7mm NVMe drives for use as boot drives. These two drives optionally support RAID via a separate RAID adapter installed in a PCIe slot.

The RAID 940-8i and RAID 940-16i adapters also support NVMe through a feature named Tri-Mode support (or Trimode support). This feature enables the use of NVMe U.3 drives at the same time as SAS and SATA drives. Tri-Mode requires an AnyBay backplane. Cabling of the controller to the backplanes is the same as with SAS/SATA drives, and the NVMe drives are connected via a PCIe x1 link to the controller.

NVMe drives connected using Tri-Mode support provide better performance than SAS or SATA drives: A SATA SSD has a data rate of 6Gbps, a SAS SSD has a data rate of 12Gbps, whereas an NVMe U.3 Gen 4 SSD with a PCIe x1 link will have a data rate of 16Gbps. NVMe drives typically also have lower latency and higher IOPS compared to SAS and SATA drives. Tri-Mode is supported with U.3 NVMe drives in either 2.5-inch and 3.5-inch form factor and requires an AnyBay backplane.

Tri-Mode requires U.3 drives: Only NVMe drives with a U.3 interface are supported. U.2 drives are not supported. See the [Internal drive options](#) section for the U.3 drives supported by the server.

Front drive bays

The front drive bay zone supports the following configurations:

- 8x or 12x 3.5-inch drive bays (all hot-swap)
- 8x, 16x or 24x 2.5-inch drive bays (all hot-swap)
- No backplanes and no drives (supports [field upgrades](#))

The specific combinations that are supported in the SR665 V3 are shown in the following figures. The feature codes listed are the backplane feature codes when ordering CTO and correspond to the feature codes listed in the table below the figure. Note that NVMe and AnyBay backplanes are available either PCIe Gen4 (G4) or PCIe Gen5 (G5).

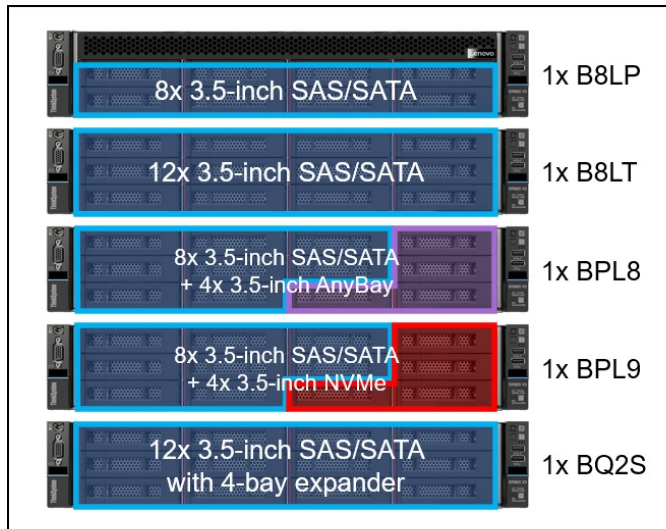

Figure 6. SR665 V3 front drive bay configurations - 3.5-inch drive bays

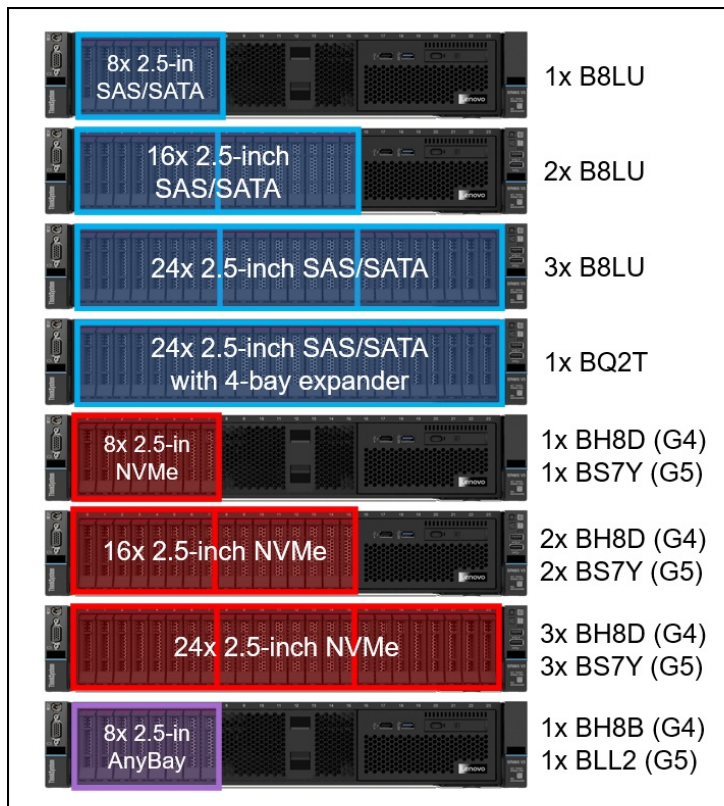

Figure 7. SR665 V3 front drive bay configurations - 2.5-inch drive bays, all the same drive type

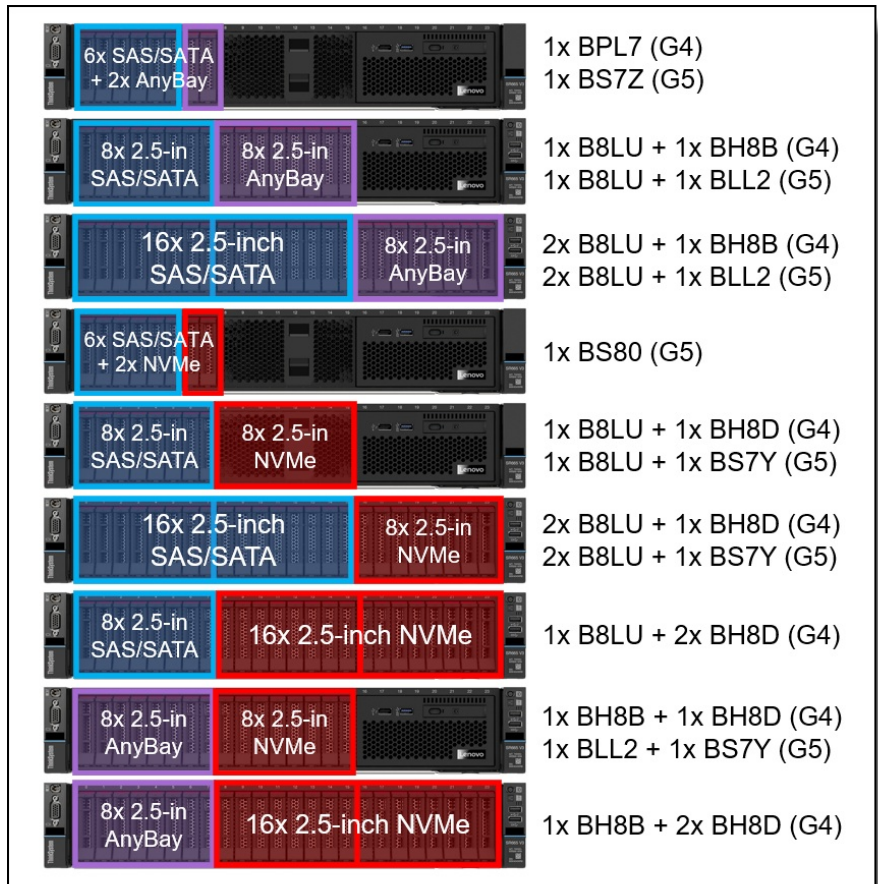

Figure 8. SR665 V3 front drive bay configurations - 2.5-inch drive bays, combinations

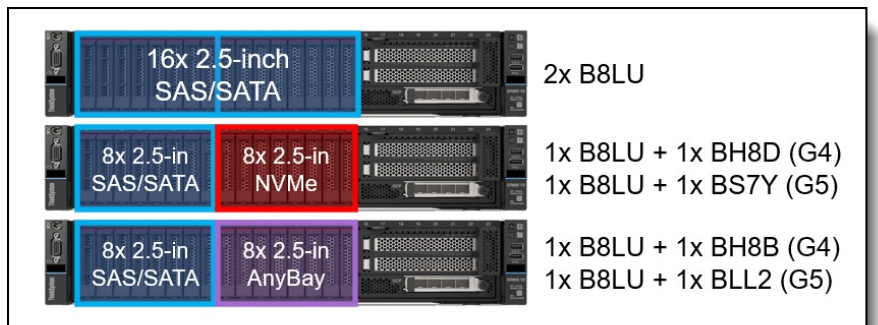

Figure 9. SR665 V3 front drive bay configurations - 2.5-inch drive bays with front PCIe slots

The backplanes used to provide these drive bays are listed in the following table.

Field upgrades: All front backplanes are available as part numbers for field upgrades along with require cable option kits, as described in the [Field upgrades](#) section below.

Table 14. Backplanes for front drive bays

Feature	Description	Bays	PCIe Gen	Maximum supported
Front 3.5-inch drive backplanes				
B8LP	ThinkSystem 2U 8x3.5" SAS/SATA Backplane	8	-	1
B8LT	ThinkSystem 2U 12x3.5" SAS/SATA Backplane	12	-	1
BPL8	ThinkSystem 2U 8x3.5" SAS/SATA+4 AnyBay Backplane	12	Gen4	1
BPL9	ThinkSystem 2U 8x3.5" SAS/SATA+4 NVMe Backplane	12	Gen4	1
BQ2S	ThinkSystem 2U 12x3.5" SAS/SATA with Rear 4-Bay Expander Backplane	12*	-	1
Front 2.5-inch drive backplanes				
B8LU	ThinkSystem 2U 8x2.5" SAS/SATA Backplane	8	-	3
BH8D	ThinkSystem 2U/4U 8x2.5" NVMe Backplane	8	Gen4	3
BS7Y	ThinkSystem V3 2U 8x2.5" NVMe Gen5 Backplane	8	Gen5	3
BH8B	ThinkSystem 2U/4U 8x2.5" AnyBay Backplane	8	Gen4	3
BLL2	ThinkSystem V3 2U 8x2.5" AnyBay Gen5 Backplane	8	Gen5	3
BPL7	ThinkSystem 2U 6x2.5" SAS/SATA+2 AnyBay Backplane	8	Gen4	1
BQ2T	ThinkSystem 2U 24x2.5" SAS/SATA with Rear 4-Bay Expander Backplane	24*	-	1
Integrated Diagnostics Panel (for 2.5-inch configurations with 8 or 16 bays only)				
BMJA	ThinkSystem 2U 16x2.5" Front Operator Panel v2	-	-	1

* Backplane has an onboard SAS expander that provides connectivity to SAS/SATA drive bays in a separate rear backplane (order the rear backplane separately). See also note below for BQ2T.

The use of front drive bays has the following configuration rules:

- The SR665 V3 also supports configurations without any drive bays, allowing for drive bay upgrades as described in the [field upgrades](#) section.
- If 3.5-inch front drive bays are used, an internal (CFF) RAID adapter or HBA is not supported as the adapter and bays occupy the same physical space
- Any 8x 2.5-inch and 16x 2.5-inch drive configuration (SAS/SATA, AnyBay, or NVMe) can optionally be configured for use with the Integrated Diagnostics Panel as described in the [Local management](#) section. 3.5-inch drive configurations do not support the Integrated Diagnostics Panel. With the Integrated Diagnostics Display, 8-bay configurations can be upgrade to 16 bays, however 16-bay configurations cannot be upgrade to 24 bays.
- If you are building a server configuration that includes the ThinkSystem 2U 24x2.5" SAS/SATA with Rear 4-Bay Expander Backplane (feature BQ2T) and the order also includes a rack cabinet, then you can configure at most 6 drives to be installed in the factory. The remaining drives must be ordered separately using the option part numbers for the drives. This requirement does not apply if the order does not include a rack cabinet. The requirement is due to the shock/vibration limits of the 24x 2.5-inch backplane.

Mid drive bays

The SR665 V3 supports hot-swap drives installed in the middle of the server chassis. The drive bays are accessible by removing the top lid of the server and levering the mid drive chassis up at the front.

The following configurations are supported:

- 4x 3.5-inch hot-swap SAS/SATA drive bays
- 8x 2.5-inch hot-swap SAS/SATA drive bays
- 8x 2.5-inch hot-swap NVMe drive bays

The drive bays in the open position are shown in the following figure.

M.2 support: When mid drive bays are configured, the M.2 adapter is installed on the mid drive bay mechanical as shown in the images.

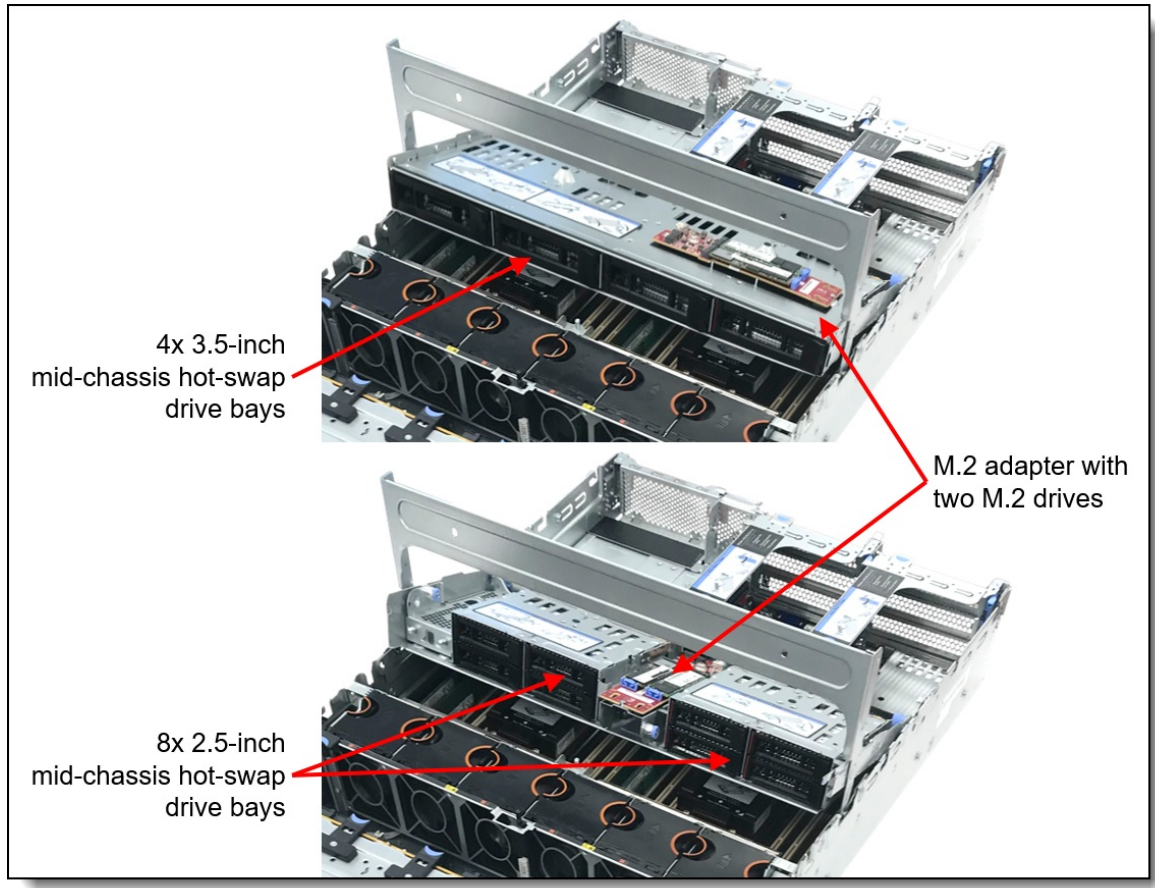

Figure 10. Mid-chassis drive bays

The backplanes used to provide these drive bays are listed in the following table.

Table 15. Backplanes for mid drive bays

Feature code	Description	PCIe Gen	Maximum supported
Mid - 3.5-inch drive backplane			
BCQK	ThinkSystem 2U 4x3.5" SAS/SATA Middle Backplane	-	1
Mid - 2.5-inch drive backplane			
BCQL	ThinkSystem 2U 4x2.5" SAS/SATA Middle Backplane	-	2‡
BDY7	ThinkSystem 2U 4x2.5" Middle NVMe Backplane	Gen4	2‡

‡ 2.5-inch drive backplanes for the mid-chassis area must be installed in pairs. NVMe and SAS/SATA cannot be mixed.

Field upgrades: Backplanes are available as part numbers for field upgrades along with require cable option kits, as described in the [Field upgrades](#) section below.

The use of drive bays in the mid-chassis area has the following configuration rules:

- All processors are supported. Higher TDP processors will require the performance heatsinks.
- Full-length adapter cards are not supported
- GPUs (including low profile GPUs such as the NVIDIA A2) are not supported
- The use of mid drive bays requires Riser 1 be installed, since power for the mid bay backplanes comes from Riser 1

Rear drive bays

The SR665 V3 supports hot-swap drives installed at the rear of the server chassis. Supported configurations are as follows:

- 3.5-inch hot-swap drives
 - 2x SAS/SATA drive bays
 - 4x SAS/SATA drive bays
- 2.5-inch hot-swap drives
 - 4x SAS/SATA drive bays
 - 4x AnyBay drive bays
 - 8x SAS/SATA drive bays

The configurations are shown in the following figure.

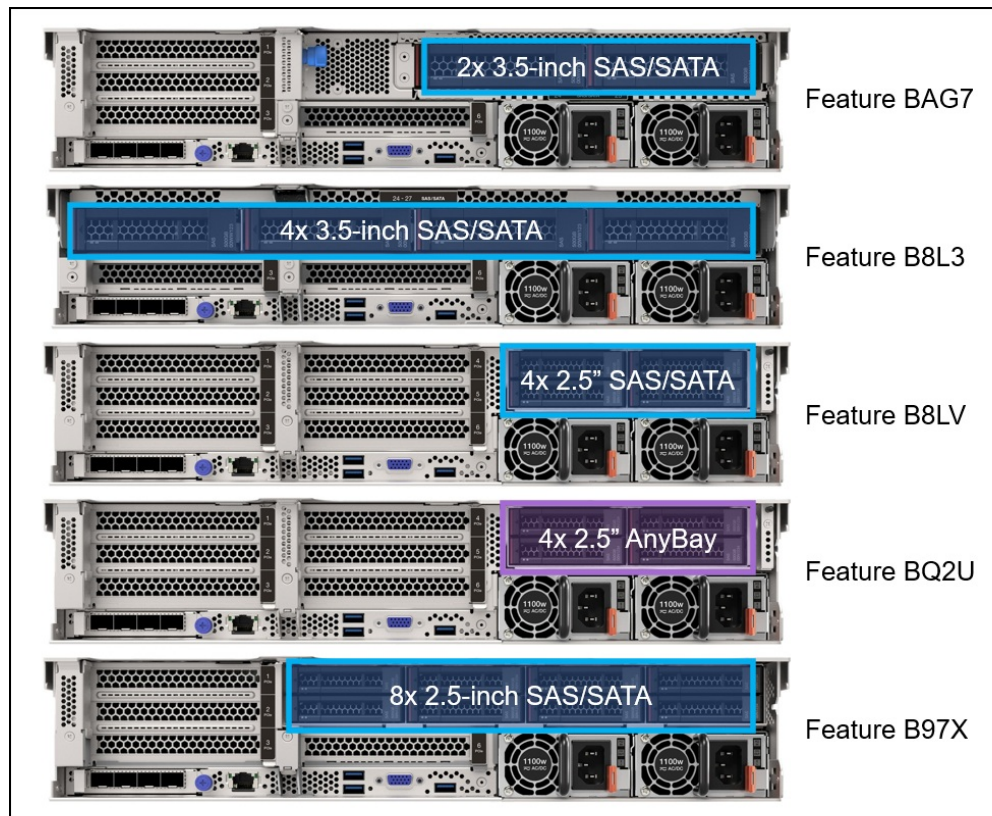

Figure 11. Rear 2.5-inch and 3.5-inch drive bay configurations

The backplanes used to provide these drive bays are listed in the following table.

7mm drives: The SR665 V3 supports two 7mm drives. See the [7mm drives](#) section for details.

Table 16. Backplanes for rear drive bays

Feature code	Description	PCIe Gen	Maximum supported
Rear - 3.5-inch drive backplanes			
BAG7	ThinkSystem 2U 2x3.5" SAS/SATA Rear Backplane	-	1
B8L3	ThinkSystem 1U/2U 4x3.5" SAS/SATA Backplane	-	1
Rear - 2.5-inch drive backplanes			
B8LV	ThinkSystem 2U 4x2.5" SAS/SATA Backplane	-	1
BQ2U	ThinkSystem V3 1U/2U 4x2.5" AnyBay Backplane	Gen4	1
B97X	ThinkSystem 2U 8x2.5" SAS/SATA Rear Backplane	1	1

Field upgrades: Backplanes are available as part numbers for field upgrades along with require cable option kits, as described in the [Field upgrades](#) section below.

The use of rear drive bays has the following configuration rules:

- The use of rear bays restricts the number of slots and the choice of risers that are supported. See the [I/O expansion](#) section for details.
- The use of rear drive bays may require that Riser 1 or Riser 2 be installed, since power for the rear backplane comes from that riser.

Storage configurations

This section describes the various combinations of front and rear drives that the server supports, as well as M.2 support.

Tip: These tables are based on Config Matrix V1.5G in TRD 3.2.

In this section:

- [Overview of configurations - 3.5-inch front drive bays](#)
- [Overview of configurations - 2.5-inch front drives supporting rear slots \(no front slots\)](#)
- [Overview of configurations - 2.5-inch front drives supporting front slots \(no rear slots\)](#)
- [Overview of configurations - 2.5-inch front drives supporting 12 slots \(front & rear\)](#)
- [Details - 3.5-inch front drive bays](#)
- [Details - 2.5-inch front drives supporting rear slots \(no front slots\)](#)
- [Details - 2.5-inch front drives supporting front slots \(no rear slots\)](#)
- [Details - 2.5-inch front drives supporting 12 slots \(front & rear\)](#)

The following tables summarize the storage configurations for the SR665 V3. For details, including processor requirements, M.2 and 7mm support, and controller selections, see each of the Details tables.

Overview - 3.5-inch front drives

The following table summarizes the configurations that use 3.5-inch front drive bays.

Click to jump down to the [details of the 3.5-inch front drive configurations](#) .

Return to [Storage configurations](#).

Table 17. Overview - 3.5-inch front drives

Config	Total drives (NVMe)	Front			Mid			Rear			Backplanes
		SAS/SATA	Any Bay	NVMe	3.5" SAS	2.5" SAS	2.5" NVMe	3.5" SAS	2.5" SAS	2.5" Any	
1	8 (0)	8	0	0	0	0	0	0	0	0	8x3.5" SAS/SATA (B8LP)
2	12 (0)	12	0	0	0	0	0	0	0	0	12x3.5" SAS/SATA (B8LT)
2A	12 (0)	12	0	0	0	0	0	0	0	0	12x3.5" SAS/SATA with Expander (BQ2S)
3	12 (4)	8	4	0	0	0	0	0	0	0	8xSAS/SATA+ 4xAnyBay G4 (BPL8)
3A	12 (4)	8	0	4	0	0	0	0	0	0	8xSAS/SATA+ 4xNVMe G4 (BPL9)
4	14 (0)	12	0	0	0	0	0	2	0	0	Front: 12x3.5" SAS/SATA (B8LT); Rear: 2x3.5" SAS/SATA (BAG7)
4A	14 (0)	12	0	0	0	0	0	2	0	0	Front: 12x3.5" SAS/SATA with Expander (BQ2S); Rear: 2x3.5" SAS/SATA (BAG7)
5	16 (0)	12	0	0	0	0	0	4	0	0	Front: 12x3.5" SAS/SATA (B8LT); Rear: 4x3.5" SAS/SATA (B8L3)
5A	16 (0)	12	0	0	0	0	0	4	0	0	Front: 12x3.5" SAS/SATA with Expander (BQ2S); Rear: 4x3.5" SAS/SATA (B8L3)
6	16 (0)	12	0	0	4	0	0	0	0	0	Front: 12x3.5" SAS/SATA (B8LT); Mid: 4x3.5" SAS/SATA (BCQK)
6A	16 (0)	12	0	0	0	4	0	0	0	0	Front: 12x3.5" SAS/SATA (B8LT); Mid: 4x2.5" SAS/SATA (BCQL)
7	16 (4)	12	0	0	0	0	0	0	0	4	Front: 12x3.5" SAS/SATA (B8LT); Rear: 4x2.5" AnyBay G4 (BQ2U)
7A	16 (4)	12	0	0	0	0	0	0	0	4	Front: 12x3.5" SAS/SATA with Expander (BQ2S); Rear: 4x2.5" AnyBay G4 (BQ2U)
7B	16 (0)	12	0	0	0	0	0	0	4	0	Front: 12x3.5" SAS/SATA (B8LT); Rear: 4x2.5" SAS/SATA (B8LV)
8	20 (0)	12	0	0	4	0	0	4	0	0	Front: 12x3.5" SAS/SATA (B8LT); Mid: 4x3.5" SAS/SATA (BCQK); Rear: 4x3.5" SAS/SATA (B8L3)
8A	20 (0)	12	0	0	4	0	0	4	0	0	Front: 12x3.5" SAS/SATA with Expander (BQ2S); Mid: 4x3.5" SAS/SATA (BCQK); Rear: 4x3.5" SAS/SATA (B8L3)
9	20 (8)	12	0	0	0	0	8	0	0	0	Front: 12x3.5" SAS/SATA (B8LT); Mid: 2x 4x2.5" NVMe G4 (BDY7)

Overview - 2.5-inch front drives supporting rear slots (no front slots)

The following table summarizes the configurations that use 2.5-inch front drives supporting rear slots (no front slots).

Click to jump down to the [details of the 2.5-inch front drive configurations](#) .

Return to [Storage configurations](#).

Table 18. Overview - 2.5-inch front drives supporting rear slots (no front slots)

Config	Total drives (NVMe)	Front			Mid			Rear			Backplanes
		SAS/SATA	Any Bay	NVMe	3.5" SAS	2.5" SAS	2.5" NVMe	3.5" SAS	2.5" SAS	2.5" Any	
10	8 (0)	8	0	0	0	0	0	0	0	0	1x 8x2.5" SAS/SATA (B8LU)
11	8 (8)	0	8	0	0	0	0	0	0	0	1x 8x2.5" AnyBay G4 (BH8B)
11B	8 (8)	0	8	0	0	0	0	0	0	0	1x 8x2.5" AnyBay G5 (BLL2)
12	8 (8)	0	0	8	0	0	0	0	0	0	1x 8x2.5" NVMe G4 (BH8D)

Config	Total drives (NVMe)	Front			Mid			Rear			Backplanes
		SAS/SATA	Any Bay	NVMe	3.5" SAS	2.5" SAS	2.5" NVMe	3.5" SAS	2.5" SAS	2.5" Any	
12B	8 (8)	0	0	8	0	0	0	0	0	0	1x 8x2.5" NVMe G5 (BS7Y)
13	8 (2)	6	2	0	0	0	0	0	0	0	6xSAS/SATA+ 2xAnyBay G4 (BPL7)
14	16 (0)	16	0	0	0	0	0	0	0	0	2x 8x2.5" SAS/SATA (B8LU)
15	16 (16)	0	8	8	0	0	0	0	0	0	8xNVMe G4 (BH8D) + 8xAnyBay G4 (BH8B)
15B	16 (16)	0	8	8	0	0	0	0	0	0	1x 8x2.5" NVMe G5 (BS7Y) + 1x 8x2.5" AnyBay G5 (BLL2)
16	16 (16)	0	0	16	0	0	0	0	0	0	2x 8xNVMe G4 (BH8D)
16	16 (16)	0	16	0	0	0	0	0	0	0	2x 8xAnyBay G4 (BH8B)
16C	16 (16)	0	0	16	0	0	0	0	0	0	2x 8x2.5" NVMe G5 (BS7Y)
17	16 (8)	8	8	0	0	0	0	0	0	0	1x 8x2.5" SAS/SATA (B8LU) + 1x 8x2.5" AnyBay G4 (BH8B)
17A	16 (8)	8	8	0	0	0	0	0	0	0	1x 8x2.5" SAS/SATA (B8LU) + 1x 8x2.5" AnyBay G5 (BLL2)
18	16 (8)	8	0	8	0	0	0	0	0	0	1x 8x2.5" SAS/SATA (B8LU) + 1x 8x2.5" NVMe G4 (BH8D)
18A	16 (8)	8	0	8	0	0	0	0	0	0	1x 8x2.5" SAS/SATA (B8LU) + 1x 8x2.5" NVMe G5 (BS7Y)
19	16 (4)	12	0	4	0	0	0	0	0	0	1x 8x2.5" SAS/SATA (B8LU) + 1x 8x2.5" AnyBay G4 (BH8B)
20	24 (8)	16	8	0	0	0	0	0	0	0	2x 8x2.5" SAS/SATA (B8LU) + 1x 8x2.5" AnyBay G4 (BH8B)
20A	24 (8)	16	8	0	0	0	0	0	0	0	2x 8x2.5" SAS/SATA (B8LU) + 1x 8x2.5" AnyBay G5 (BLL2)
21	24 (8)	16	0	8	0	0	0	0	0	0	2x 8x2.5" SAS/SATA (B8LU) + 1x 8x2.5" NVMe G4 (BH8D)
21A	24 (8)	16	0	8	0	0	0	0	0	0	2x 8x2.5" SAS/SATA (B8LU) + 1x 8x2.5" NVMe G5 (BS7Y)
22	24 (0)	24	0	0	0	0	0	0	0	0	3x 8x2.5" SAS/SATA (B8LU)
22A	24 (0)	24	0	0	0	0	0	0	0	0	24x2.5" SAS/SATA with Expander (BQ2T)
23	24 (24)	0	0	24	0	0	0	0	0	0	3x 8xNVMe G4 (BH8D)
23	24 (24)	0	24	0	0	0	0	0	0	0	3x 8xAnyBay G4 (BH8B)
24	24 (24)	0	8	16	0	0	0	0	0	0	1x 8xAnyBay G4 (BH8B) + 2x 8xNVMe G4 (BH8D)
24B	24 (16)	8	0	16	0	0	0	0	0	0	1x 8x2.5" SAS/SATA (B8LU) + 2x 8x2.5" NVMe G4 (BH8D)
26	28 (0)	24	0	0	0	0	0	0	4	0	Front: 3x 8x2.5" SAS/SATA (B8LU); Rear: 4x2.5" SAS/SATA (B8LV)
26A	28 (0)	24	0	0	0	0	0	0	4	0	Front: 24x2.5" SAS/SATA with Expander (BQ2T); Rear: 4x2.5" SAS/SATA (B8LV)
27	28 (0)	24	0	0	0	4	0	0	0	0	Front: 3x 8x2.5" SAS/SATA (B8LU); Mid: 4x2.5" SAS/SATA (BCQL)
28	28 (4)	24	0	0	0	0	0	0	0	4	Front: 3x 8x2.5" SAS/SATA (B8LU); Rear: 4x2.5" AnyBay G4 (BQ2U)
28A	28 (4)	24	0	0	0	0	0	0	0	4	Front: 24x2.5" SAS/SATA with Expander (BQ2T); Rear: 4x2.5" AnyBay G4 (BQ2U)
29	32 (0)	24	0	0	0	0	0	0	8	0	Front: 3x 8x2.5" SAS/SATA (B8LU); Rear: 8x2.5" SAS/SATA (B97X)
29A	32 (0)	24	0	0	0	0	0	0	8	0	Front: 24x2.5" SAS/SATA with Expander (BQ2T); Rear: 8x2.5" SAS/SATA (B97X)

Config	Total drives (NVMe)	Front			Mid			Rear			Backplanes
		SAS/SATA	Any Bay	NVMe	3.5" SAS	2.5" SAS	2.5" NVMe	3.5" SAS	2.5" SAS	2.5" Any	
30	32 (32)	0	0	24	0	0	8	0	0	0	Front: 3x 8xNVMe G4 (BH8D); Mid: 2x 4x2.5" NVMe G4 (BDY7)
31	32 (0)	24	0	0	0	8	0	0	0	0	Front: 3x 8x2.5" SAS/SATA (B8LU); Mid: 2x 4x2.5" SAS/SATA (BCQL)
32	36 (0)	24	0	0	0	8	0	0	4	0	Front: 3x 8x2.5" SAS/SATA (B8LU); Mid: 2x 4x2.5" SAS/SATA (BCQL); Rear: 4x2.5" SAS/SATA (B8LV)
33	40 (0)	24	0	0	0	8	0	0	8	0	Front: 3x 8x2.5" SAS/SATA (B8LU); Mid: 2x 4x2.5" SAS/SATA (BCQL); Rear: 8x2.5" SAS/SATA (B97X)

Overview - 2.5-inch front drives supporting front slots (no rear slots)

The following table summarizes the configurations that use 2.5-inch front drives supporting front slots (no rear slots).

Click to jump down to the [details of the 2.5-inch front drive configurations](#) .

Return to [Storage configurations](#).

Table 19. Overview - 2.5-inch front drives supporting front slots (no rear slots)

Config	Total drives (NVMe)	Front			Mid			Rear			Backplanes
		SAS/SATA	Any Bay	NVMe	3.5" SAS	2.5" SAS	2.5" NVMe	3.5" SAS	2.5" SAS	2.5" Any	
10	8 (0)	8	0	0	0	0	0	0	0	0	1x 8x2.5" SAS/SATA (B8LU)
11D	8 (8)	0	8	0	0	0	0	0	0	0	1x 8x2.5" AnyBay G4 (BH8B)
11E	8 (8)	0	8	0	0	0	0	0	0	0	1x 8x2.5" AnyBay G5 (BLL2)
12D	8 (8)	0	0	8	0	0	0	0	0	0	1x 8x2.5" NVMe G4 (BH8D)
12E	8 (8)	0	0	8	0	0	0	0	0	0	1x 8x2.5" NVMe G5 (BS7Y)
13D	8 (2)	6	2	0	0	0	0	0	0	0	6xSAS/SATA+ 2xAnyBay G4 (BPL7)
14	16 (0)	16	0	0	0	0	0	0	0	0	2x 8x2.5" SAS/SATA (B8LU)
16	16 (16)	0	16	0	0	0	0	0	0	0	2x 8xAnyBay G4 (BH8B)
17D	16 (8)	8	8	0	0	0	0	0	0	0	1x 8x2.5" SAS/SATA (B8LU) + 1x 8x2.5" AnyBay G4 (BH8B)
17A	16 (8)	8	8	0	0	0	0	0	0	0	1x 8x2.5" SAS/SATA (B8LU) + 1x 8x2.5" AnyBay G5 (BLL2)
18D	16 (8)	8	0	8	0	0	0	0	0	0	1x 8x2.5" SAS/SATA (B8LU) + 1x 8x2.5" NVMe G4 (BH8D)
18E	16 (8)	8	0	8	0	0	0	0	0	0	1x 8x2.5" SAS/SATA (B8LU) + 1x 8x2.5" NVMe G5 (BS7Y)
26A	20 (0)	16	0	0	0	0	0	0	4	0	Front: 2x 8x2.5" SAS/SATA (B8LU); Rear: 4x2.5" SAS/SATA (B8LV)
27	20 (0)	16	0	0	0	4	0	0	0	0	Front: 2x 8x2.5" SAS/SATA (B8LU); Mid: 4x2.5" SAS/SATA (BCQL)
29	24 (0)	16	0	0	0	0	0	0	8	0	Front: 2x 8x2.5" SAS/SATA (B8LU); Rear: 8x2.5" SAS/SATA (B97X)
31	24 (0)	16	0	0	0	8	0	0	0	0	Front: 2x 8x2.5" SAS/SATA (B8LU); Mid: 2x 4x2.5" SAS/SATA (BCQL)
32A	28 (0)	16	0	0	0	8	0	0	4	0	Front: 2x 8x2.5" SAS/SATA (B8LU); Mid: 2x 4x2.5" SAS/SATA (BCQL); Rear: 4x2.5" SAS/SATA (B8LV)
33	32 (0)	16	0	0	0	8	0	0	8	0	Front: 2x 8x2.5" SAS/SATA (B8LU); Mid: 2x 4x2.5" SAS/SATA (BCQL); Rear: 8x2.5" SAS/SATA (B97X)

Overview - 2.5-inch front drives supporting 12 slots (front & rear)

The following table summarizes the configurations that use 2.5-inch front drives supporting 12 slots (front & rear).

Click to jump down to the [details of the 2.5-inch front drive configurations](#) .

Return to [Storage configurations](#).

Table 20. Overview - 2.5-inch front drives supporting 12 slots (front & rear)

Config	Total drives (NVMe)	Front			Mid			Rear			Backplanes
		SAS/SATA	Any Bay	NVMe	3.5" SAS	2.5" SAS	2.5" NVMe	3.5" SAS	2.5" SAS	2.5" Any	
10	8 (0)	8	0	0	0	0	0	0	0	0	1x 8x2.5" SAS/SATA (B8LU)
11F	8 (8)	0	8	0	0	0	0	0	0	0	1x 8x2.5" AnyBay G4 (BH8B)
12F	8 (8)	0	0	8	0	0	0	0	0	0	1x 8x2.5" NVMe G4 (BH8D)
13	8 (2)	6	2	0	0	0	0	0	0	0	6xSAS/SATA+ 2xAnyBay G4 (BPL7)
14	16 (0)	16	0	0	0	0	0	0	0	0	2x 8x2.5" SAS/SATA (B8LU)
16	16 (16)	0	16	0	0	0	0	0	0	0	2x 8xAnyBay G4 (BH8B)
17F	16 (8)	8	8	0	0	0	0	0	0	0	1x 8x2.5" SAS/SATA (B8LU) + 1x 8x2.5" AnyBay G4 (BH8B)
18F	16 (8)	8	0	8	0	0	0	0	0	0	1x 8x2.5" SAS/SATA (B8LU) + 1x 8x2.5" NVMe G4 (BH8D)
27A	20 (0)	16	0	0	0	4	0	0	0	0	Front: 2x 8x2.5" SAS/SATA (B8LU); Mid: 4x2.5" SAS/SATA (BCQL)
31A	24 (0)	16	0	0	0	8	0	0	0	0	Front: 2x 8x2.5" SAS/SATA (B8LU); Mid: 2x 4x2.5" SAS/SATA (BCQL)

Details - 3.5-inch front bays

The following table details the configurations that use 3.5-inch front drive bays.

Click to go to the [overview of the 3.5-inch front drive configurations](#).

Return to [Storage configurations](#).

Table 21. Details - 3.5-inch front bays

Config	CPUs	Front			Mid			Rear			Backplanes	M.2				7mm				Supported controllers
		SAS/SATA	AnyBay	NVMe	3.5" SAS/SATA	2.5" SAS/SATA	2.5" NVMe	3.5" SAS/SATA	2.5" SAS/SATA	2.5" AnyBay		M.2 Non-RAID (SATA)	M.2 Non-RAID (NVMe)	M.2 + RAID adapter	M.2 RAID (NVMe)	7mm Non-RAID (SATA)	7mm Non-RAID (NVMe)	7mm + RAID adapter	7mm RAID (NVMe)	
1-1	1 or 2	8	0	0	0	0	0	0	0	0	8x3.5" SAS/SATA (B8LP)	Y	Y	Y	Y	Y	Y	Y	Y	OB SATA
1-2	1 or 2											Y	Y	Y	Y	Y	Y	Y	Y	(5350-8i or 9350-8i or 4350-8i)
1-3	1 or 2											Y	Y	Y	Y	Y	Y	Y	Y	(940-8i or 540-8i or 440-8i)
2-1	2 only	12	0	0	0	0	0	0	0	0	12x3.5" SAS/SATA (B8LT)	Y	Y	Y	Y	Y	Y	Y	Y	OB SATA
2-1A	1 only											N	N	Y	Y	N	Y	Y	Y	OB SATA
2-2	1 or 2											Y	Y	Y	Y	Y	Y	Y	Y	(9350-16i or 4350-16i)
2-3	1 or 2											Y	Y	Y	Y	Y	Y	Y	Y	(940-16i or 540-16i or 440-16i)
2A-1	1 or 2	12	0	0	0	0	0	0	0	0	12x3.5" SAS/SATA with Expander (BQ2S)	Y	Y	Y	Y	Y	Y	Y	Y	(5350-8i or 9350-8i or 4350-8i)
2A-2	1 or 2											Y	Y	Y	Y	Y	Y	Y	Y	(940-8i or 540-8i or 440-8i)

Config	CPUs	Front		Mid			Rear			Backplanes	M.2				7mm				Supported controllers	
		SAS/SATA	AnyBay	NVMe	3.5" SAS/SATA	2.5" SAS/SATA	2.5" NVMe	3.5" SAS/SATA	2.5" SAS/SATA		2.5" AnyBay	M.2 Non-RAID (SATA)	M.2 Non-RAID (NVMe)	M.2 + RAID adapter	M.2 RAID (NVMe)	7mm Non-RAID (SATA)	7mm Non-RAID (NVMe)	7mm + RAID adapter		7mm RAID (NVMe)
3-1	2 only	8	4	0	0	0	0	0	0	0	8xSAS/SATA+ 4xAnyBay G4 (BPL8)	N	N	Y	Y	N	Y	Y	Y	(9350-16i or 4350-16i) + OB NVMe
3-2	2 only											N	N	Y	Y	N	Y	Y	Y	(940-16i or 540-16i or 440-16i) + OB NVMe
3-3	1 only											Y	Y	Y	Y	Y	Y	Y	Y	(9350-16i or 4350-16i) + OB NVMe
3-4	1 only											Y	Y	Y	Y	Y	Y	Y	Y	(940-16i or 540-16i or 440-16i) + OB NVMe
3A-1	2 only	8	0	4	0	0	0	0	0	0	8xSAS/SATA+ 4xNVMe G4 (BPL9)	N	N	Y	Y	N	Y	Y	Y	OB SATA + OB NVMe
3A-2	2 only											N	N	Y	Y	N	Y	Y	Y	(5350-8i or 9350-8i or 4350-8i) + OB NVMe
3A-3	2 only											N	N	Y	Y	N	Y	Y	Y	(940-8i or 540-8i or 440- 8i) + OB NVMe
3A-4	1 only											Y	Y	Y	Y	Y	Y	Y	Y	OB SATA + OB NVMe
3A-5	1 only											Y	Y	Y	Y	Y	Y	Y	Y	(5350-8i or 9350-8i or 4350-8i) + OB NVMe
3A-6	1 only											Y	Y	Y	Y	Y	Y	Y	Y	(940-8i or 540-8i or 440- 8i) + OB NVMe
4-1	2 only	12	0	0	0	0	0	2	0	0	Front: 12x3.5" SAS/SATA (B8LT); Rear: 2x3.5" SAS/SATA (BAG7)	Y	Y	Y	Y	Y	Y	Y	Y	Front: OB SATA; Rear: OB SATA
4-1A	1 only											N	N	Y	Y	N	Y	Y	Y	Front: OB SATA; Rear: OB SATA
4-2	1 or 2											Y	Y	Y	Y	Y	Y	Y	Y	(9350-16i or 4350-16i)
4-3	1 or 2											Y	Y	Y	Y	Y	Y	Y	Y	(940-16i or 540-16i or 440-16i)
4A-1	1 or 2	12	0	0	0	0	0	2	0	0	Front: 12x3.5" SAS/SATA with Expander (BQ2S); Rear: 2x3.5" SAS/SATA (BAG7)	Y	Y	Y	Y	Y	Y	Y	Y	(5350-8i or 9350-8i or 4350-8i)
4A-2	1 or 2											Y	Y	Y	Y	Y	Y	Y	Y	(940-8i or 540-8i or 440- 8i)
5-1	2 only	12	0	0	0	0	0	4	0	0	Front: 12x3.5" SAS/SATA (B8LT); Rear: 4x3.5" SAS/SATA (B8L3)	Y	Y	Y	Y	Y	Y	Y	Y	Front: OB SATA; Rear: OB SATA
5-1A	1 only											N	N	Y	Y	N	Y	Y	Y	Front: OB SATA; Rear: OB SATA
5-2	1 or 2											Y	Y	Y	Y	Y	Y	Y	Y	(9350-16i or 4350-16i)
5-3	1 or 2											Y	Y	Y	Y	Y	Y	Y	Y	(940-16i or 540-16i or 440-16i)
5A-1	1 or 2	12	0	0	0	0	0	4	0	0	Front: 12x3.5" SAS/SATA with Expander (BQ2S); Rear: 4x3.5" SAS/SATA (B8L3)	Y	Y	Y	Y	Y	Y	Y	Y	(5350-8i or 9350-8i or 4350-8i)
5A-2	1 or 2											Y	Y	Y	Y	Y	Y	Y	Y	(940-8i or 540-8i or 440- 8i)
6-1	1 or 2	12	0	0	4	0	0	0	0	0	Front: 12x3.5" SAS/SATA (B8LT); Mid: 4x3.5" SAS/SATA (BCQK)	Y	Y	Y	Y	N	N	Y	Y	(9350-16i or 4350-16i)
6-2	1 or 2											Y	Y	Y	Y	N	N	Y	Y	(940-16i or 540-16i or 440-16i)

Config	CPUs	Front		Mid			Rear			Backplanes	M.2				7mm				Supported controllers		
		SAS/SATA	AnyBay	NVMe	3.5" SAS/SATA	2.5" SAS/SATA	2.5" NVMe	3.5" SAS/SATA	2.5" SAS/SATA		2.5" AnyBay	M.2 Non-RAID (SATA)	M.2 Non-RAID (NVMe)	M.2 + RAID adapter	M.2 RAID (NVMe)	7mm Non-RAID (SATA)	7mm Non-RAID (NVMe)	7mm + RAID adapter		7mm RAID (NVMe)	
6A-1	1 or 2	12	0	0	0	4	0	0	0	0	Front: 12x3.5" SAS/SATA (B8LT); Mid: 4x2.5" SAS/SATA (BCQL)	Y	Y	Y	Y	N	N	Y	Y	(9350-16i or 4350-16i)	
6A-2	1 or 2												Y	Y	Y	Y	N	N	Y	Y	(940-16i or 540-16i or 440-16i)
7-1	2 only	12	0	0	0	0	0	0	0	4	Front: 12x3.5" SAS/SATA (B8LT); Rear: 4x2.5" AnyBay G4 (BQ2U)	Y	Y	Y	Y	N	N	Y	Y	Front: (9350-16i or 4350-16i); Rear: OB NVMe	
7-2	2 only												Y	Y	Y	Y	N	N	Y	Y	Front: (940-16i or 540-16i or 440-16i); Rear: OB NVMe
7-3	1 only												N	N	Y	Y	N	N	Y	Y	Front: (9350-16i or 4350-16i); Rear: OB NVMe
7-4	1 only												N	N	Y	Y	N	N	Y	Y	Front: (940-16i or 540-16i or 440-16i); Rear: OB NVMe
7A-1	2 only	12	0	0	0	0	0	0	0	4	Front: 12x3.5" SAS/SATA with Expander (BQ2S); Rear: 4x2.5" AnyBay G4 (BQ2U)	Y	Y	Y	Y	N	N	Y	Y	Front: (5350-8i or 9350-8i or 4350-8i); Rear: OB NVMe	
7A-2	2 only												Y	Y	Y	Y	N	N	Y	Y	Front: (940-8i or 540-8i or 440-8i); Rear: OB NVMe
7A-3	1 only												N	N	Y	Y	N	N	Y	Y	Front: (5350-8i or 9350-8i or 4350-8i); Rear: OB NVMe
7A-4	1 only												N	N	Y	Y	N	N	Y	Y	Front: (940-8i or 540-8i or 440-8i); Rear: OB NVMe
7B-1	1 or 2	12	0	0	0	0	0	0	4	0	Front: 12x3.5" SAS/SATA (B8LT); Rear: 4x2.5" SAS/SATA (B8LV)	Y	Y	Y	Y	N	N	Y	Y	(9350-16i or 4350-16i)	
7B-2	1 or 2												Y	Y	Y	Y	N	N	Y	Y	(940-16i or 540-16i or 440-16i)
8-2	1 or 2	12	0	0	4	0	0	4	0	0	Front: 12x3.5" SAS/SATA (B8LT); Mid: 4x3.5" SAS/SATA (BCQK); Rear: 4x3.5" SAS/SATA (B8L3)	Y	Y	Y	Y	N	N	Y	Y	940-32i	
8A-1	1 or 2	12	0	0	4	0	0	4	0	0	Front: 12x3.5" SAS/SATA with Expander (BQ2S); Mid: 4x3.5" SAS/SATA (BCQK); Rear: 4x3.5" SAS/SATA (B8L3)	Y	Y	Y	Y	N	N	Y	Y	(9350-16i or 4350-16i)	
8A-2	1 or 2												Y	Y	Y	Y	N	N	Y	Y	(940-16i or 540-16i or 440-16i)

Config	CPUs	Front			Mid			Rear			Backplanes	M.2				7mm				Supported controllers
		SAS/SATA	AnyBay	NVMe	3.5" SAS/SATA	2.5" SAS/SATA	2.5" NVMe	3.5" SAS/SATA	2.5" SAS/SATA	2.5" AnyBay		M.2 Non-RAID (SATA)	M.2 Non-RAID (NVMe)	M.2 + RAID adapter	M.2 RAID (NVMe)	7mm Non-RAID (SATA)	7mm Non-RAID (NVMe)	7mm + RAID adapter	7mm RAID (NVMe)	
9-1	2 only	12	0	0	0	0	8	0	0	0	Front: 12x3.5" SAS/SATA (B8LT); Mid: 2x 4x2.5" NVMe G4 (BDY7)	N	N	Y	Y	N	N	Y	Y	Front: (9350-16i or 4350-16i); Mid: OB NVMe
9-2	2 only											N	N	Y	Y	N	N	Y	Y	

Details - 2.5-inch front bays supporting rear slots (no front slots)

The following table details the configurations that use 2.5-inch front bays supporting rear slots (no front slots).

Click to go to the [overview of the 2.5-inch front drive configurations](#) .

Return to [Storage configurations](#).

Table 22. Details - 2.5-inch front bays supporting rear slots (no front slots)

Config	CPUs	Front			Mid			Rear			Backplanes	M.2				7mm				Supported controllers
		SAS/SATA	AnyBay	NVMe	3.5" SAS/SATA	2.5" SAS/SATA	2.5" NVMe	3.5" SAS/SATA	2.5" SAS/SATA	2.5" AnyBay		M.2 Non-RAID (SATA)	M.2 Non-RAID (NVMe)	M.2 + RAID adapter	M.2 RAID (NVMe)	7mm Non-RAID (SATA)	7mm Non-RAID (NVMe)	7mm + RAID adapter	7mm RAID (NVMe)	
10-1	2 only	8	0	0	0	0	0	0	0	0	1x 8x2.5" SAS/SATA (B8LU)	Y	Y	Y	Y	Y	Y	Y	Y	OB SATA
10-1A	1 only											Y	Y	Y	Y	Y	Y	Y	Y	OB SATA
10-2	1 or 2											Y	Y	Y	Y	Y	Y	Y	Y	(5350-8i or 9350-8i or 4350-8i)
10-3	1 or 2											Y	Y	Y	Y	Y	Y	Y	Y	(940-8i or 540-8i or 440-8i)
10-4	1 or 2											Y	Y	Y	Y	Y	Y	Y	Y	(9350-16i or 4350-16i)
10-5	1 or 2											Y	Y	Y	Y	Y	Y	Y	Y	(940-16i or 540-16i or 440-16i)
10-6	2 only											Y	Y	Y	Y	Y	Y	Y	Y	(9350-8i CFF or 940-16i CFF or 5350-8i CFF or 440-16i CFF)
10-6A	1 only											Y	Y	Y	Y	Y	Y	Y	Y	(9350-8i CFF or 940-16i CFF or 5350-8i CFF or 440-16i CFF)
11-1	2 only	0	8	0	0	0	0	0	0	0	1x 8x2.5" AnyBay G4 (BH8B)	N	N	Y	Y	N	Y	Y	Y	(5350-8i or 9350-8i or 4350-8i) + OB NVMe
11-2	2 only											N	N	Y	Y	N	Y	Y	Y	(940-8i or 540-8i or 440-8i) + OB NVMe

Config	CPUs	Front		Mid			Rear			Backplanes	M.2				7mm				Supported controllers	
		SAS/SATA	AnyBay	NVMe	3.5" SAS/SATA	2.5" SAS/SATA	2.5" NVMe	3.5" SAS/SATA	2.5" SAS/SATA		2.5" AnyBay	M.2 Non-RAID (SATA)	M.2 Non-RAID (NVMe)	M.2 + RAID adapter	M.2 RAID (NVMe)	7mm Non-RAID (SATA)	7mm Non-RAID (NVMe)	7mm + RAID adapter		7mm RAID (NVMe)
11-3	2 only										N	N	Y	Y	N	Y	Y	Y	(9350-16i or 4350-16i) + OB NVMe	
11-4	2 only										N	N	Y	Y	N	Y	Y	Y	(940-16i or 540-16i or 440-16i) + OB NVMe	
11-5	2 only										N	N	Y	Y	N	Y	Y	Y	(9350-8i CFF or 940-16i CFF or 5350-8i CFF or 440-16i CFF) + OB NVMe	
11A-1	2 only										Y	Y	Y	Y	Y	Y	Y	Y	(5350-8i or 9350-8i or 4350-8i) + OB NVMe	
11A-2	2 only										Y	Y	Y	Y	Y	Y	Y	Y	(940-8i or 540-8i or 440-8i) + OB NVMe	
11A-3	2 only										Y	Y	Y	Y	Y	Y	Y	Y	(9350-16i or 4350-16i) + OB NVMe	
11A-4	2 only										Y	Y	Y	Y	Y	Y	Y	Y	(940-16i or 540-16i or 440-16i) + OB NVMe	
11A-5	2 only										Y	Y	Y	Y	Y	Y	Y	Y	(9350-8i CFF or 940-16i CFF or 5350-8i CFF or 440-16i CFF) + OB NVMe	
11-6	1 only										N	N	Y	Y	N	Y	Y	Y	(5350-8i or 9350-8i or 4350-8i) + OB NVMe	
11-7	1 only										N	N	Y	Y	N	Y	Y	Y	(940-8i or 540-8i or 440-8i) + OB NVMe	
11-8	1 only										N	N	Y	Y	N	Y	Y	Y	(9350-16i or 4350-16i) + OB NVMe	
11-9	1 only										N	N	Y	Y	N	Y	Y	Y	(940-16i or 540-16i or 440-16i) + OB NVMe	
11B-1	2 only	0	8	0	0	0	0	0	0	0	1x 8x2.5" AnyBay G5 (BLL2)	N	N	Y	Y	N	Y	Y	Y	(5350-8i or 9350-8i or 4350-8i) + OB NVMe
11B-2	2 only											N	N	Y	Y	N	Y	Y	Y	(940-8i or 540-8i or 440-8i) + OB NVMe
11B-3	2 only											N	N	Y	Y	N	Y	Y	Y	(9350-16i or 4350-16i) + OB NVMe
11B-4	2 only											N	N	Y	Y	N	Y	Y	Y	(940-16i or 540-16i or 440-16i) + OB NVMe
11B-5	2 only											N	N	Y	Y	N	Y	Y	Y	(9350-8i CFF or 940-16i CFF or 5350-8i CFF or 440-16i CFF) + OB NVMe
11C-1	2 only											Y	Y	Y	Y	Y	Y	Y	Y	(5350-8i or 9350-8i or 4350-8i) + OB NVMe
11C-2	2 only											Y	Y	Y	Y	Y	Y	Y	Y	(940-8i or 540-8i or 440-8i) + OB NVMe
11C-3	2 only											Y	Y	Y	Y	Y	Y	Y	Y	(9350-16i or 4350-16i) + OB NVMe

Config	CPUs	Front		Mid			Rear			Backplanes	M.2				7mm				Supported controllers		
		SAS/SATA	AnyBay	NVMe	3.5" SAS/SATA	2.5" SAS/SATA	2.5" NVMe	3.5" SAS/SATA	2.5" SAS/SATA		2.5" AnyBay	M.2 Non-RAID (SATA)	M.2 Non-RAID (NVMe)	M.2 + RAID adapter	M.2 RAID (NVMe)	7mm Non-RAID (SATA)	7mm Non-RAID (NVMe)	7mm + RAID adapter		7mm RAID (NVMe)	
11C-4	2 only										Y	Y	Y	Y	Y	Y	Y	Y	(940-16i or 540-16i or 440-16i) + OB NVMe		
11C-5	2 only										Y	Y	Y	Y	Y	Y	Y	Y	(9350-8i CFF or 940-16i CFF or 5350-8i CFF or 440-16i CFF) + OB NVMe		
11B-6	1 only										N	N	Y	Y	N	Y	Y	Y	(5350-8i or 9350-8i or 4350-8i) + OB NVMe		
11B-7	1 only										N	N	Y	Y	N	Y	Y	Y	(940-8i or 540-8i or 440-8i) + OB NVMe		
11B-8	1 only										N	N	Y	Y	N	Y	Y	Y	(9350-16i or 4350-16i) + OB NVMe		
11B-9	1 only										N	N	Y	Y	N	Y	Y	Y	(940-16i or 540-16i or 440-16i) + OB NVMe		
12-1	2 only	0	0	8	0	0	0	0	0	0	1x 8x2.5" NVMe G4 (BH8D)	N	N	Y	Y	N	Y	Y	Y	OB NVMe	
12A-1	2 only											Y	Y	Y	Y	Y	Y	Y	Y	OB NVMe	
12-2	1 only											N	N	Y	Y	N	Y	Y	Y	OB NVMe	
12B-1	2 only	0	0	8	0	0	0	0	0	0	1x 8x2.5" NVMe G5 (BS7Y)	N	N	Y	Y	N	Y	Y	Y	OB NVMe	
12C-1	2 only											Y	Y	Y	Y	Y	Y	Y	Y	OB NVMe	
12B-2	1 only											N	N	Y	Y	N	Y	Y	Y	OB NVMe	
13-1	2 only	6	2	0	0	0	0	0	0	0	6xSAS/SATA+ 2xAnyBay G4 (BPL7)	Y	Y	Y	Y	Y	Y	Y	Y	(5350-8i or 9350-8i or 4350-8i) + OB NVMe	
13-2	2 only											Y	Y	Y	Y	Y	Y	Y	Y	(940-8i or 540-8i or 440-8i) + OB NVMe	
13-3	2 only											Y	Y	Y	Y	Y	Y	Y	Y	OB SATA + OB NVMe	
13-4	1 only											Y	Y	Y	Y	Y	Y	Y	Y	(5350-8i or 9350-8i or 4350-8i) + OB NVMe	
13-5	1 only											Y	Y	Y	Y	Y	Y	Y	Y	(940-8i or 540-8i or 440-8i) + OB NVMe	
13-6	1 only											Y	Y	Y	Y	Y	Y	Y	Y	OB SATA + OB NVMe	
14-1	2 only	16	0	0	0	0	0	0	0	0	2x 8x2.5" SAS/SATA (B8LU)	Y	Y	Y	Y	Y	Y	Y	Y	Y	OB SATA
14-1A	1 only											N	N	Y	Y	N	Y	Y	Y	OB SATA	
14-2	1 or 2											Y	Y	Y	Y	Y	Y	Y	Y	(9350-16i or 4350-16i)	
14-3	1 or 2											Y	Y	Y	Y	Y	Y	Y	Y	(940-16i or 540-16i or 440-16i)	
14-6	2 only											Y	Y	Y	Y	Y	Y	Y	Y	(9350-16i CFF or 940-16i CFF or 440-16i CFF)	
14-6A	1 only											Y	Y	Y	Y	Y	Y	Y	Y	(9350-8i CFF or 940-16i CFF or 440-16i CFF)	
15-1	2 only	0	8	8	0	0	0	0	0	0	8xNVMe G4 (BH8D) + 8xAnyBay G4 (BH8B)	N	N	Y	Y	N	Y	Y	Y	(5350-8i or 9350-8i or 4350-8i) + OB NVMe	
15-2	2 only											N	N	Y	Y	N	Y	Y	Y	(940-8i or 540-8i or 440-8i) + OB NVMe	

Config	CPUs	Front		Mid			Rear			Backplanes	M.2				7mm				Supported controllers
		SAS/SATA	AnyBay	NVMe	3.5" SAS/SATA	2.5" SAS/SATA	2.5" NVMe	3.5" SAS/SATA	2.5" SAS/SATA		2.5" AnyBay	M.2 Non-RAID (SATA)	M.2 Non-RAID (NVMe)	M.2 + RAID adapter	M.2 RAID (NVMe)	7mm Non-RAID (SATA)	7mm Non-RAID (NVMe)	7mm + RAID adapter	
15A-1	2 only										Y	Y	Y	Y	Y	Y	Y	Y	(5350-8i or 9350-8i or 4350-8i) + OB NVMe
15A-2	2 only										Y	Y	Y	Y	Y	Y	Y	Y	(940-8i or 540-8i or 440-8i) + OB NVMe
15-3	2 only										N	N	Y	Y	N	Y	Y	Y	(5350-8i or 9350-8i or 4350-8i) + OB NVMe
15-4	2 only										N	N	Y	Y	N	Y	Y	Y	(940-8i or 540-8i or 440-8i) + OB NVMe
15B-1	2 only	0	8	8	0	0	0	0	0	0	N	N	Y	Y	N	Y	Y	Y	(5350-8i or 9350-8i or 4350-8i) + OB NVMe
15B-2	2 only										N	N	Y	Y	N	Y	Y	Y	(940-8i or 540-8i or 440-8i) + OB NVMe
15C-1	2 only										Y	Y	Y	Y	Y	Y	Y	Y	(5350-8i or 9350-8i or 4350-8i) + OB NVMe
15C-2	2 only										Y	Y	Y	Y	Y	Y	Y	Y	(940-8i or 540-8i or 440-8i) + OB NVMe
16-1	2 only	0	0	16	0	0	0	0	0	0	N	N	Y	Y	N	Y	Y	Y	Retimer + OB NVMe
16A-1	2 only										Y	Y	Y	Y	Y	Y	Y	Y	OB NVMe
16-2	2 only										N	N	Y	Y	N	Y	Y	Y	OB NVMe
16-3	1 or 2	0	16	0	0	0	0	0	0	0	Y	Y	Y	Y	Y	Y	Y	Y	940-16i Tri-mode
16-4	1 or 2										Y	Y	Y	Y	Y	Y	Y	Y	2x 940-8i Tri-mode
16C-1	2 only	0	0	16	0	0	0	0	0	0	Y	Y	Y	Y	Y	Y	Y	Y	OB NVMe
16B-2	2 only										N	N	Y	Y	N	Y	Y	Y	OB NVMe
17-1	2 only	8	8	0	0	0	0	0	0	0	N	N	Y	Y	N	Y	Y	Y	(9350-16i CFF or 940-16i CFF or 440-16i CFF) + OB NVMe
17-2	2 only										N	N	Y	Y	N	Y	Y	Y	(9350-16i or 4350-16i) + OB NVMe
17-3	2 only										N	N	Y	Y	N	Y	Y	Y	(940-16i or 540-16i or 440-16i) + OB NVMe
17-4	2 only										N	N	Y	Y	N	Y	Y	Y	(2x 5350-8i or 2x 9350-8i or 2x 4350-8i) + OB NVMe
17-5	2 only										N	N	Y	Y	N	Y	Y	Y	2x (940-8i or 540-8i or 440-8i) + OB NVMe
17-6	1 only										N	N	Y	Y	N	Y	Y	Y	(9350-16i or 4350-16i) + OB NVMe
17-7	1 only										N	N	Y	Y	N	Y	Y	Y	(940-16i or 540-16i or 440-16i) + OB NVMe
17-8	1 only										N	N	Y	Y	N	Y	Y	Y	(2x 5350-8i or 2x 9350-8i or 2x 4350-8i) + OB NVMe
17-9	1 only										N	N	Y	Y	N	Y	Y	Y	2x (940-8i or 540-8i or 440-8i) + OB NVMe

Config	CPUs	Front			Mid			Rear			Backplanes	M.2				7mm				Supported controllers
		SAS/SATA	AnyBay	NVMe	3.5" SAS/SATA	2.5" SAS/SATA	2.5" NVMe	3.5" SAS/SATA	2.5" SAS/SATA	2.5" AnyBay		M.2 Non-RAID (SATA)	M.2 Non-RAID (NVMe)	M.2 + RAID adapter	M.2 RAID (NVMe)	7mm Non-RAID (SATA)	7mm Non-RAID (NVMe)	7mm + RAID adapter	7mm RAID (NVMe)	
17A-1	2 only	8	8	0	0	0	0	0	0	0	1x 8x2.5" SAS/SATA (B8LU) + 1x 8x2.5" AnyBay G5 (BLL2)	N	N	Y	Y	N	Y	Y	Y	(9350-16i CFF or 940-16i CFF or 440-16i CFF) + OB NVMe
17A-2	2 only											N	N	Y	Y	N	Y	Y	Y	(9350-16i or 4350-16i) + OB NVMe
17A-3	2 only											N	N	Y	Y	N	Y	Y	Y	(940-16i or 540-16i or 440-16i) + OB NVMe
17A-4	2 only											N	N	Y	Y	N	Y	Y	Y	(2x 5350-8i or 2x 9350-8i or 2x 4350-8i) + OB NVMe
17A-5	2 only											N	N	Y	Y	N	Y	Y	Y	2x (940-8i or 540-8i or 440-8i) + OB NVMe
17A-6	1 only											N	N	Y	Y	N	Y	Y	Y	(9350-16i or 4350-16i) + OB NVMe
17A-7	1 only											N	N	Y	Y	N	Y	Y	Y	(940-16i or 540-16i or 440-16i) + OB NVMe
17A-8	1 only											N	N	Y	Y	N	Y	Y	Y	(2x 5350-8i or 2x 9350-8i or 2x 4350-8i) + OB NVMe
17A-9	1 only											N	N	Y	Y	N	Y	Y	Y	2x (940-8i or 540-8i or 440-8i) + OB NVMe
18-1	2 only	8	0	8	0	0	0	0	0	0	1x 8x2.5" SAS/SATA (B8LU) + 1x 8x2.5" NVMe G4 (BH8D)	N	N	Y	Y	N	Y	Y	Y	(5350-8i or 9350-8i or 4350-8i) + OB NVMe
18-2	2 only											N	N	Y	Y	N	Y	Y	Y	(940-8i or 540-8i or 440-8i) + OB NVMe
18-3	1 only											N	N	Y	Y	N	Y	Y	Y	(5350-8i or 9350-8i or 4350-8i) + OB NVMe
18-4	1 only											N	N	Y	Y	N	Y	Y	Y	(940-8i or 540-8i or 440-8i) + OB NVMe
18A-1	2 only	8	0	8	0	0	0	0	0	0	1x 8x2.5" SAS/SATA (B8LU) + 1x 8x2.5" NVMe G5 (BS7Y)	N	N	Y	Y	N	Y	Y	Y	(5350-8i or 9350-8i or 4350-8i) + OB NVMe
18A-2	2 only											N	N	Y	Y	N	Y	Y	Y	(940-8i or 540-8i or 440-8i) + OB NVMe
18A-3	1 only											N	N	Y	Y	N	Y	Y	Y	(5350-8i or 9350-8i or 4350-8i) + OB NVMe
18A-4	1 only											N	N	Y	Y	N	Y	Y	Y	(940-8i or 540-8i or 440-8i) + OB NVMe
19-1	2 only	12	0	4	0	0	0	0	0	0	1x 8x2.5" SAS/SATA (B8LU) + 1x 8x2.5" AnyBay G4 (BH8B)	N	N	Y	Y	N	Y	Y	Y	OB SATA + OB NVMe
19-2	1 only											N	N	Y	Y	N	Y	Y	Y	OB SATA + OB NVMe
20-1	2 only	16	8	0	0	0	0	0	0	0	2x 8x2.5" SAS/SATA (B8LU) + 1x 8x2.5" AnyBay G4 (BH8B)	N	N	Y	Y	N	Y	Y	Y	940-32i + OB NVMe
20-5	2 only											N	N	Y	Y	N	Y	Y	Y	3x (940-8i or 540-8i or 440-8i) + OB NVMe
20-6	1 only											N	N	Y	Y	N	Y	Y	Y	940-32i + OB NVMe

Config	CPUs	Front			Mid			Rear			Backplanes	M.2				7mm				Supported controllers
		SAS/SATA	AnyBay	NVMe	3.5" SAS/SATA	2.5" SAS/SATA	2.5" NVMe	3.5" SAS/SATA	2.5" SAS/SATA	2.5" AnyBay		M.2 Non-RAID (SATA)	M.2 Non-RAID (NVMe)	M.2 + RAID adapter	M.2 RAID (NVMe)	7mm Non-RAID (SATA)	7mm Non-RAID (NVMe)	7mm + RAID adapter	7mm RAID (NVMe)	
20A-6	1 only	16	8	0	0	0	0	0	0	0	2x 8x2.5" SAS/SATA (B8LU) + 1x 8x2.5" AnyBay G5 (BLL2)	N	N	Y	Y	N	Y	Y	Y	940-32i + OB NVMe
21-1	2 only	16	0	8	0	0	0	0	0	0	2x 8x2.5" SAS/SATA (B8LU) + 1x 8x2.5" NVMe G4 (BH8D)	N	N	Y	Y	N	Y	Y	Y	(9350-16i CFF or 940-16i CFF or 440-16i CFF) + OB NVMe
21-2	2 only											N	N	Y	Y	N	Y	Y	Y	(9350-16i or 4350-16i) + OB NVMe
21-3	2 only											N	N	Y	Y	N	Y	Y	Y	(940-16i or 540-16i or 440-16i) + OB NVMe
21-4	2 only											N	N	Y	Y	N	Y	Y	Y	(2x 5350-8i or 2x 9350-8i or 2x 4350-8i) + OB NVMe
21-5	2 only											N	N	Y	Y	N	Y	Y	Y	2x (940-8i or 540-8i or 440-8i) + OB NVMe
21-6	1 only											N	N	Y	Y	N	Y	Y	Y	(9350-16i or 4350-16i) + OB NVMe
21-7	1 only											N	N	Y	Y	N	Y	Y	Y	(940-16i or 540-16i or 440-16i) + OB NVMe
21-8	1 only											N	N	Y	Y	N	Y	Y	Y	(2x 5350-8i or 2x 9350-8i or 2x 4350-8i) + OB NVMe
21-9	1 only											N	N	Y	Y	N	Y	Y	Y	2x (940-8i or 540-8i or 440-8i) + OB NVMe
21A-6	1 only	16	0	8	0	0	0	0	0	0	2x 8x2.5" SAS/SATA (B8LU) + 1x 8x2.5" NVMe G5 (BS7Y)	N	N	Y	Y	N	Y	Y	Y	(9350-16i or 4350-16i) + OB NVMe
21A-7	1 only											N	N	Y	Y	N	Y	Y	Y	(940-16i or 540-16i or 440-16i) + OB NVMe
21A-8	1 only											N	N	Y	Y	N	Y	Y	Y	(2x 5350-8i or 2x 9350-8i or 2x 4350-8i) + OB NVMe
21A-9	1 only											N	N	Y	Y	N	Y	Y	Y	2x (940-8i or 540-8i or 440-8i) + OB NVMe
22-1	1 or 2	24	0	0	0	0	0	0	0	0	3x 8x2.5" SAS/SATA (B8LU)	Y	Y	Y	Y	Y	Y	Y	Y	940-32i
22-2	1 or 2											Y	Y	Y	Y	Y	Y	Y	Y	3x (5350-8i or 9350-8i or 4350-8i)
22-3	1 or 2											Y	Y	Y	Y	Y	Y	Y	Y	3x (940-8i or 540-8i or 440-8i)
22-4	1 or 2											Y	Y	Y	Y	Y	Y	Y	Y	(9350-16i or 4350-16i) + (5350-8i or 9350-8i or 4350-8i)
22-5	1 or 2											Y	Y	Y	Y	Y	Y	Y	Y	(940-16i or 540-16i or 440-16i) + (940-8i or 540-8i or 440-8i)

Config	CPUs	Front			Mid			Rear			Backplanes	M.2				7mm				Supported controllers
		SAS/SATA	AnyBay	NVMe	3.5" SAS/SATA	2.5" SAS/SATA	2.5" NVMe	3.5" SAS/SATA	2.5" SAS/SATA	2.5" AnyBay		M.2 Non-RAID (SATA)	M.2 Non-RAID (NVMe)	M.2 + RAID adapter	M.2 RAID (NVMe)	7mm Non-RAID (SATA)	7mm Non-RAID (NVMe)	7mm + RAID adapter	7mm RAID (NVMe)	
22A-1	1 or 2	24	0	0	0	0	0	0	0	0	24x2.5" SAS/SATA with Expander (BQ2T)	Y	Y	Y	Y	Y	Y	Y	Y	(5350-8i or 9350-8i or 4350-8i)
22A-2	1 or 2											Y	Y	Y	Y	Y	Y	Y	Y	(940-8i or 540-8i or 440-8i)
23-1	2 only	0	0	24	0	0	0	0	0	0	3x 8xNVMe G4 (BH8D)	N	N	Y	Y	N	Y	Y	Y	OB NVMe + Retimer
23-2	2 only											N	N	Y	Y	N	Y	Y	Y	OB NVMe + 3x Retimer
23-3	1 or 2	0	24	0	0	0	0	0	0	0	3x 8xAnyBay G4 (BH8B)	Y	Y	Y	Y	Y	Y	Y	Y	940-8i Tri-mode + 940-16i Tri-mode
23-4	1 or 2											Y	Y	Y	Y	Y	Y	Y	Y	3x 940-8i Tri-mode
24-1	2 only	0	8	16	0	0	0	0	0	0	1x 8xAnyBay G4 (BH8B) + 2x 8xNVMe G4 (BH8D)	N	N	Y	Y	N	Y	Y	Y	(5350-8i or 9350-8i or 4350-8i) + OB NVMe
24-2	2 only											N	N	Y	Y	N	Y	Y	Y	(940-8i or 540-8i or 440-8i) + OB NVMe
24-3	2 only											N	N	Y	Y	N	Y	Y	Y	(5350-8i or 9350-8i or 4350-8i) + OB NVMe
24-4	2 only											N	N	Y	Y	N	Y	Y	Y	(940-8i or 540-8i or 440-8i) + OB NVMe
24B-1	2 only	8	0	16	0	0	0	0	0	0	1x 8x2.5" SAS/SATA (B8LU) + 2x 8x2.5" NVMe G4 (BH8D)	N	N	Y	Y	N	Y	Y	Y	(5350-8i or 9350-8i or 4350-8i) + OB NVMe
24B-2	2 only											N	N	Y	Y	N	Y	Y	Y	(940-8i or 540-8i or 440-8i) + OB NVMe
24B-3	2 only											Y	Y	Y	Y	Y	Y	Y	Y	(5350-8i or 9350-8i or 4350-8i) + OB NVMe
24B-4	2 only											Y	Y	Y	Y	Y	Y	Y	Y	(940-8i or 540-8i or 440-8i) + OB NVMe
26-1	1 or 2	24	0	0	0	0	0	0	4	0	Front: 3x 8x2.5" SAS/SATA (B8LU); Rear: 4x2.5" SAS/SATA (B8LV)	Y	Y	Y	Y	N	N	Y	Y	940-32i
26-2	2 only											Y	Y	Y	Y	N	N	Y	Y	(9350-16i CFF or 940-16i CFF or 440-16i CFF) + Exp-44i
26-3	1 only											Y	Y	Y	Y	N	N	Y	Y	(9350-16i CFF or 940-16i CFF or 440-16i CFF) + Exp-44i
26-4	1 or 2											Y	Y	Y	Y	N	N	Y	Y	(5350-8i or 9350-8i or 4350-8i) + Exp-44i
26-5	1 or 2											Y	Y	Y	Y	N	N	Y	Y	(940-8i or 540-8i or 440-8i) + Exp-44i
26-6	1 or 2											Y	Y	Y	Y	N	N	Y	Y	(9350-16i or 4350-16i) + Exp-44i
26-7	1 or 2											Y	Y	Y	Y	N	N	Y	Y	(940-16i or 540-16i or 440-16i) + Exp-44i
26A-1	1 or 2	24	0	0	0	0	0	0	4	0	Front: 24x2.5" SAS/SATA with Expander (BQ2T); Rear: 4x2.5" SAS/SATA (B8LV)	Y	Y	Y	Y	N	N	Y	Y	(5350-8i or 9350-8i or 4350-8i)
26A-2	1 or 2											Y	Y	Y	Y	N	N	Y	Y	(940-8i or 540-8i or 440-8i)

Config	CPUs	Front			Mid			Rear			Backplanes	M.2				7mm				Supported controllers	
		SAS/SATA	AnyBay	NVMe	3.5" SAS/SATA	2.5" SAS/SATA	2.5" NVMe	3.5" SAS/SATA	2.5" SAS/SATA	2.5" AnyBay		M.2 Non-RAID (SATA)	M.2 Non-RAID (NVMe)	M.2 + RAID adapter	M.2 RAID (NVMe)	7mm Non-RAID (SATA)	7mm Non-RAID (NVMe)	7mm + RAID adapter	7mm RAID (NVMe)		
27-1	1 or 2	24	0	0	0	4	0	0	0	0	Front: 3x 8x2.5" SAS/SATA (B8LU); Mid: 4x2.5" SAS/SATA (BCQL)	Y	Y	Y	Y	N	N	Y	Y	940-32i	
27-2	1 or 2											Y	Y	Y	Y	N	N	Y	Y	2x (9350-16i or 4350-16i)	
27-3	1 or 2											Y	Y	Y	Y	N	N	Y	Y	2x (940-16i or 540-16i or 440-16i)	
28-1	2 only	24	0	0	0	0	0	0	0	4	Front: 3x 8x2.5" SAS/SATA (B8LU); Rear: 4x2.5" AnyBay G4 (BQ2U)	Y	Y	Y	Y	N	N	Y	Y	Front: 940-32i; Rear: OB NVMe	
28-4	2 only											Y	Y	Y	Y	N	N	Y	Y	Front: (9350-16i CFF or 940-16i CFF or 440-16i CFF) + Exp-44i; Rear: OB NVMe	
28-5	2 only											Y	Y	Y	Y	N	N	Y	Y	Front: (5350-8i or 9350-8i or 4350-8i) + Exp-44i; Rear: OB NVMe	
28-6	2 only											Y	Y	Y	Y	N	N	Y	Y	Front: (940-8i or 540-8i or 440-8i) + Exp-44i; Rear: OB NVMe	
28-7	2 only											Y	Y	Y	Y	N	N	Y	Y	Front: (9350-16i or 4350-16i) + Exp-44i; Rear: OB NVMe	
28-8	2 only											Y	Y	Y	Y	N	N	Y	Y	Front: (940-16i or 540-16i or 440-16i) + Exp-44i; Rear: OB NVMe	
28-9	1 only											N	N	Y	Y	N	N	Y	Y	Front: 940-32i; Rear: OB NVMe	
28-10	1 only											N	N	Y	Y	N	N	Y	Y	Front: (9350-16i CFF or 940-16i CFF or 440-16i CFF) + Exp-44i; Rear: OB NVMe	
28-11	1 only											N	N	Y	Y	N	N	Y	Y	Front: (5350-8i or 9350-8i or 4350-8i) + Exp-44i; Rear: OB NVMe	
28-12	1 only											N	N	Y	Y	N	N	Y	Y	Front: (940-8i or 540-8i or 440-8i) + Exp-44i; Rear: OB NVMe	
28-13	1 only											N	N	Y	Y	N	N	Y	Y	Front: (9350-16i or 4350-16i) + Exp-44i; Rear: OB NVMe	
28-14	1 only											N	N	Y	Y	N	N	Y	Y	Front: (940-16i or 540-16i or 440-16i) + Exp-44i; Rear: OB NVMe	
28A-1	2 only	24	0	0	0	0	0	0	0	4		Front: 24x2.5" SAS/SATA with Expander (BQ2T); Rear: 4x2.5" AnyBay G4 (BQ2U)	Y	Y	Y	Y	N	N	Y	Y	Front: (5350-8i or 9350-8i or 4350-8i); Rear: OB NVMe
28A-2	2 only												Y	Y	Y	Y	N	N	Y	Y	Front: (940-8i or 540-8i or 440-8i); Rear: OB NVMe

Config	CPUs	Front		Mid			Rear		Backplanes	M.2				7mm				Supported controllers
		SAS/SATA	AnyBay	NVMe	3.5" SAS/SATA	2.5" SAS/SATA	2.5" NVMe	3.5" SAS/SATA		2.5" SAS/SATA	2.5" AnyBay	M.2 Non-RAID (SATA)	M.2 Non-RAID (NVMe)	M.2 + RAID adapter	M.2 RAID (NVMe)	7mm Non-RAID (SATA)	7mm Non-RAID (NVMe)	
28A-3	1 only									N	N	Y	Y	N	N	Y	Y	Front: (5350-8i or 9350-8i or 4350-8i); Rear: OB NVMe
28A-4	1 only									N	N	Y	Y	N	N	Y	Y	Front: (940-8i or 540-8i or 440-8i); Rear: OB NVMe
29-1	1 or 2	24	0	0	0	0	0	0	8	0	Y	Y	Y	Y	Y	Y	Y	Front: 3x 8x2.5" SAS/SATA (B8LU); Rear: 8x2.5" SAS/SATA (B97X)
29-2	2 only									Y	Y	Y	Y	Y	Y	Y	Y	2x (9350-16i or 4350-16i)
29-3	2 only									Y	Y	Y	Y	Y	Y	Y	Y	2x (940-16i or 540-16i or 440-16i)
29-4	2 only									Y	Y	Y	Y	Y	Y	Y	Y	Front: 9350-16i CFF; Rear: (9350-16i or 4350-16i)
29-4A	1 only									Y	Y	Y	Y	Y	Y	Y	Y	Front: 9350-16i CFF; Rear: (9350-16i or 4350-16i)
29-5	2 only									Y	Y	Y	Y	Y	Y	Y	Y	Front: (940-16i CFF or 440-16i CFF); Rear: (940-16i or 540-16i or 440-16i)
29-5A	1 only									Y	Y	Y	Y	Y	Y	Y	Y	Front: (940-16i CFF or 440-16i CFF); Rear: (940-16i or 540-16i or 440-16i)
29-6	1 or 2									Y	Y	Y	Y	Y	Y	Y	Y	(5350-8i or 9350-8i or 4350-8i) + Exp-44i
29-7	1 or 2									Y	Y	Y	Y	Y	Y	Y	Y	(940-8i or 540-8i or 440-8i) + Exp-44i
29-8	1 or 2									Y	Y	Y	Y	Y	Y	Y	Y	(9350-16i or 4350-16i) + Exp-44i
29-9	1 or 2									Y	Y	Y	Y	Y	Y	Y	Y	(940-16i or 540-16i or 440-16i) + Exp-44i
29-10	2 only									Y	Y	Y	Y	Y	Y	Y	Y	(9350-16i CFF or 940-16i CFF or 440-16i CFF) + Exp-44i
29-10A	1 only									Y	Y	Y	Y	Y	Y	Y	Y	(9350-16i CFF or 940-16i CFF or 440-16i CFF) + Exp-44i
29A-1	1 or 2	24	0	0	0	0	0	0	8	0	Y	Y	Y	Y	Y	Y	Y	Front: 24x2.5" SAS/SATA with Expander (BQ2T); Rear: 8x2.5" SAS/SATA (B97X)
29A-2	1 or 2									Y	Y	Y	Y	Y	Y	Y	Y	(940-16i or 540-16i or 440-16i)
29A-3	2 only									Y	Y	Y	Y	Y	Y	Y	Y	(9350-16i CFF or 940-16i CFF or 440-16i CFF)

Config	CPUs	Front			Mid			Rear			Backplanes	M.2				7mm				Supported controllers
		SAS/SATA	AnyBay	NVMe	3.5" SAS/SATA	2.5" SAS/SATA	2.5" NVMe	3.5" SAS/SATA	2.5" SAS/SATA	2.5" AnyBay		M.2 Non-RAID (SATA)	M.2 Non-RAID (NVMe)	M.2 + RAID adapter	M.2 RAID (NVMe)	7mm Non-RAID (SATA)	7mm Non-RAID (NVMe)	7mm + RAID adapter	7mm RAID (NVMe)	
29A-3A	1 only											Y	Y	Y	Y	Y	Y	Y	(9350-16i CFF or 940-16i CFF or 440-16i CFF)	
30-1	2 only	0	0	24	0	0	8	0	0	0	Front: 3x 8xNVMe G4 (BH8D); Mid: 2x 4x2.5" NVMe G4 (BDY7)	N	N	Y	Y	N	Y	Y	Y	Front: Retimer + OB NVMe; Mid: 2x Retimer
31-1	1 or 2	24	0	0	0	8	0	0	0	0	Front: 3x 8x2.5" SAS/SATA (B8LU); Mid: 2x 4x2.5" SAS/SATA (BCQL)	Y	Y	Y	Y	N	N	Y	Y	940-32i
31-2	2 only											Y	Y	Y	Y	N	N	Y	Y	2x (9350-16i or 4350-16i)
31-3	2 only											Y	Y	Y	Y	N	N	Y	Y	2x (940-16i or 540-16i or 440-16i)
32-1	1 or 2	24	0	0	0	8	0	0	4	0	Front: 3x 8x2.5" SAS/SATA (B8LU); Mid: 2x 4x2.5" SAS/SATA (BCQL); Rear: 4x2.5" SAS/SATA (B8LV)	Y	Y	Y	Y	N	N	Y	Y	Front: 940-32i; Mid: (940-8i or 540-8i or 440-8i)
32-2	1 or 2											Y	Y	Y	Y	N	N	Y	Y	(5350-8i or 9350-8i or 4350-8i) + Exp-44i
32-3	1 or 2											Y	Y	Y	Y	N	N	Y	Y	(940-8i or 540-8i or 440-8i) + Exp-44i
32-4	1 or 2											Y	Y	Y	Y	N	N	Y	Y	(9350-16i or 4350-16i) + Exp-44i
32-5	1 or 2											Y	Y	Y	Y	N	N	Y	Y	(940-16i or 540-16i or 440-16i) + Exp-44i
32-6	2 only											Y	Y	Y	Y	N	N	Y	Y	(9350-16i CFF or 940-16i CFF or 440-16i CFF) + Exp-44i
32-6A	1 only											Y	Y	Y	Y	N	N	Y	Y	(9350-16i CFF or 940-16i CFF or 440-16i CFF) + Exp-44i
33-1	2 only	24	0	0	0	8	0	0	8	0	Front: 3x 8x2.5" SAS/SATA (B8LU); Mid: 2x 4x2.5" SAS/SATA (BCQL); Rear: 8x2.5" SAS/SATA (B97X)	Y	Y	Y	Y	N	N	Y	Y	Front: (9350-16i CFF or 940-16i CFF or 440-16i CFF) + Exp-44i; Mid: Exp-44i
33-2	1 only											Y	Y	Y	Y	N	N	Y	Y	Front: (9350-16i CFF or 940-16i CFF or 440-16i CFF) + Exp-44i; Mid: Exp-44i
33-3	1 or 2											Y	Y	Y	Y	N	N	Y	Y	Front: (9350-16i or 4350-16i) + Exp-44i; Mid: Exp-44i
33-4	1 or 2											Y	Y	Y	Y	N	N	Y	Y	Front: (940-16i or 540-16i or 440-16i) + Exp-44i; Mid: Exp-44i

Details - 2.5-inch front bays supporting front slots (no rear slots)

The following table details the configurations that use 2.5-inch front bays supporting front slots (no rear slots).

Click to go to the [overview of the 2.5-inch front drive configurations](#).

Return to [Storage configurations](#).

Table 23. Details - 2.5-inch front bays supporting front slots (no rear slots)

Config	CPUs	Front			Mid			Rear			Backplanes	M.2				7mm				Supported controllers
		SAS/SATA	AnyBay	NVMe	3.5" SAS/SATA	2.5" SAS/SATA	2.5" NVMe	3.5" SAS/SATA	2.5" SAS/SATA	2.5" AnyBay		M.2 Non-RAID (SATA)	M.2 Non-RAID (NVMe)	M.2 + RAID adapter	M.2 RAID (NVMe)	7mm Non-RAID (SATA)	7mm Non-RAID (NVMe)	7mm + RAID adapter	7mm RAID (NVMe)	
10-2	1 or 2	8	0	0	0	0	0	0	0	0	1x 8x2.5" SAS/SATA (B8LU)	N	Y	Y	Y	Y	Y	Y	Y	(5350-8i or 9350-8i or 4350-8i)
10-3	1 or 2											N	Y	Y	Y	Y	Y	Y	Y	(940-8i or 540-8i or 440-8i)
10-4	1 or 2											N	Y	Y	Y	Y	Y	Y	Y	(9350-16i or 4350-16i)
10-5	1 or 2											N	Y	Y	Y	Y	Y	Y	Y	(940-16i or 540-16i or 440-16i)
11D-1	2 only	0	8	0	0	0	0	0	0	0	1x 8x2.5" AnyBay G4 (BH8B)	N	Y	Y	Y	N	Y	Y	Y	(5350-8i or 9350-8i or 4350-8i) + OB NVMe
11D-2	2 only											N	Y	Y	Y	N	Y	Y	Y	(940-8i or 540-8i or 440-8i) + OB NVMe
11D-3	2 only											N	Y	Y	Y	N	Y	Y	Y	(9350-16i or 4350-16i) + OB NVMe
11D-4	2 only											N	Y	Y	Y	N	Y	Y	Y	(940-16i or 540-16i or 440-16i) + OB NVMe
11E-1	2 only	0	8	0	0	0	0	0	0	0	1x 8x2.5" AnyBay G5 (BLL2)	N	Y	Y	Y	N	Y	Y	Y	(5350-8i or 9350-8i or 4350-8i) + OB NVMe
11E-2	2 only											N	Y	Y	Y	N	Y	Y	Y	(940-8i or 540-8i or 440-8i) + OB NVMe
11E-3	2 only											N	Y	Y	Y	N	Y	Y	Y	(9350-16i or 4350-16i) + OB NVMe
11E-4	2 only											N	Y	Y	Y	N	Y	Y	Y	(940-16i or 540-16i or 440-16i) + OB NVMe
12D-1	2 only	0	0	8	0	0	0	0	0	0	1x 8x2.5" NVMe G4 (BH8D)	N	Y	Y	Y	N	Y	Y	Y	OB NVMe
12E-1	2 only	0	0	8	0	0	0	0	0	0	1x 8x2.5" NVMe G5 (BS7Y)	N	Y	Y	Y	N	Y	Y	Y	OB NVMe
13D-1	2 only	6	2	0	0	0	0	0	0	0	6xSAS/SATA+ 2xAnyBay G4 (BPL7)	Y	Y	Y	Y	Y	Y	Y	Y	(5350-8i or 9350-8i or 4350-8i) + OB NVMe
13D-2	2 only											Y	Y	Y	Y	Y	Y	Y	Y	(940-8i or 540-8i or 440-8i) + OB NVMe
14-2	1 or 2	16	0	0	0	0	0	0	0	0	2x 8x2.5" SAS/SATA (B8LU)	Y	Y	Y	Y	Y	Y	Y	Y	(9350-16i or 4350-16i)
14-3	1 or 2											Y	Y	Y	Y	Y	Y	Y	Y	(940-16i or 540-16i or 440-16i)
16-3	1 or 2	0	16	0	0	0	0	0	0	0	2x 8xAnyBay G4 (BH8B)	N	Y	Y	Y	Y	Y	Y	Y	940-16i Tri-mode
16-4	1 or 2											N	Y	Y	Y	Y	Y	Y	Y	2x 940-8i Tri-mode

Config	CPUs	Front		Mid			Rear			Backplanes	M.2				7mm				Supported controllers	
		SAS/SATA	AnyBay	NVMe	3.5" SAS/SATA	2.5" SAS/SATA	2.5" NVMe	3.5" SAS/SATA	2.5" SAS/SATA		2.5" AnyBay	M.2 Non-RAID (SATA)	M.2 Non-RAID (NVMe)	M.2 + RAID adapter	M.2 RAID (NVMe)	7mm Non-RAID (SATA)	7mm Non-RAID (NVMe)	7mm + RAID adapter		7mm RAID (NVMe)
17D-2	2 only	8	8	0	0	0	0	0	0	0	1x 8x2.5" SAS/SATA (B8LU) + 1x 8x2.5" AnyBay G4 (BH8B)	N	Y	Y	Y	N	Y	Y	Y	(9350-16i or 4350-16i) + OB NVMe
17D-3	2 only											N	Y	Y	Y	N	Y	Y	Y	(940-16i or 540-16i or 440-16i) + OB NVMe
17D-4	2 only											N	Y	Y	Y	N	Y	Y	Y	(2x 5350-8i or 2x 9350-8i or 2x 4350-8i) + OB NVMe
17D-5	2 only											N	Y	Y	Y	N	Y	Y	Y	2x (940-8i or 540-8i or 440-8i) + OB NVMe
17A-1	2 only	8	8	0	0	0	0	0	0	0	1x 8x2.5" SAS/SATA (B8LU) + 1x 8x2.5" AnyBay G5 (BLL2)	N	Y	Y	Y	N	Y	Y	Y	(9350-16i CFF or 940-16i CFF or 440-16i CFF) + OB NVMe
17E-2	2 only											N	Y	Y	Y	N	Y	Y	Y	(9350-16i or 4350-16i) + OB NVMe
17E-3	2 only											N	Y	Y	Y	N	Y	Y	Y	(940-16i or 540-16i or 440-16i) + OB NVMe
17E-4	2 only											N	Y	Y	Y	N	Y	Y	Y	(2x 5350-8i or 2x 9350-8i or 2x 4350-8i) + OB NVMe
17E-5	2 only											N	Y	Y	Y	N	Y	Y	Y	2x (940-8i or 540-8i or 440-8i) + OB NVMe
18D-1	2 only	8	0	8	0	0	0	0	0	0	1x 8x2.5" SAS/SATA (B8LU) + 1x 8x2.5" NVMe G4 (BH8D)	N	Y	Y	Y	N	Y	Y	Y	(5350-8i or 9350-8i or 4350-8i) + OB NVMe
18D-2	2 only											N	Y	Y	Y	N	Y	Y	Y	(940-8i or 540-8i or 440-8i) + OB NVMe
18E-1	2 only	8	0	8	0	0	0	0	0	0	1x 8x2.5" SAS/SATA (B8LU) + 1x 8x2.5" NVMe G5 (BS7Y)	N	Y	Y	Y	N	Y	Y	Y	(5350-8i or 9350-8i or 4350-8i) + OB NVMe
18E-2	2 only											N	Y	Y	Y	N	Y	Y	Y	(940-8i or 540-8i or 440-8i) + OB NVMe
26A-1	1 or 2	16	0	0	0	0	0	0	4	0	Front: 2x 8x2.5" SAS/SATA (B8LU); Rear: 4x2.5" SAS/SATA (B8LV)	Y	Y	Y	Y	N	N	Y	Y	Front: (940-16i or 540-16i or 440-16i); Rear: (940-8i or 540-8i or 440-8i)
26A-2	1 or 2											Y	Y	Y	Y	N	N	Y	Y	Front: (9350-16i or 4350-16i); Rear: (5350-8i or 9350-8i or 4350-8i)
27-1	1 or 2	16	0	0	0	4	0	0	0	0	Front: 2x 8x2.5" SAS/SATA (B8LU); Mid: 4x2.5" SAS/SATA (BCQL)	Y	Y	Y	Y	Y	Y	Y	Y	940-32i
27A-2	1 or 2											Y	Y	Y	Y	Y	Y	Y	Y	Front: (9350-16i or 4350-16i); Mid: (5350-8i or 9350-8i or 4350-8i)
29-1	1 or 2	16	0	0	0	0	0	0	8	0	Front: 2x 8x2.5" SAS/SATA (B8LU); Rear: 8x2.5" SAS/SATA (B97X)	Y	Y	Y	Y	Y	Y	Y	Y	940-32i
29-6	1 or 2											Y	Y	Y	Y	Y	Y	Y	Y	(5350-8i or 9350-8i or 4350-8i) + Exp-44i
29-7	1 or 2											Y	Y	Y	Y	Y	Y	Y	Y	(940-8i or 540-8i or 440-8i) + Exp-44i

Config	CPUs	Front		Mid			Rear			Backplanes	M.2				7mm				Supported controllers
		SAS/SATA	AnyBay	NVMe	3.5" SAS/SATA	2.5" SAS/SATA	2.5" NVMe	3.5" SAS/SATA	2.5" SAS/SATA		2.5" AnyBay	M.2 Non-RAID (SATA)	M.2 Non-RAID (NVMe)	M.2 + RAID adapter	M.2 RAID (NVMe)	7mm Non-RAID (SATA)	7mm Non-RAID (NVMe)	7mm + RAID adapter	
29-8	1 or 2										Y	Y	Y	Y	Y	Y	Y	Y	(9350-16i or 4350-16i) + Exp-44i
29-9	1 or 2										Y	Y	Y	Y	Y	Y	Y	Y	(940-16i or 540-16i or 440-16i) + Exp-44i
31-1	1 or 2	16	0	0	0	8	0	0	0	0	Y	Y	Y	Y	Y	Y	Y	Y	940-32i
31A-3	2 only										Y	Y	Y	Y	Y	Y	Y	Y	Front: (940-16i or 540-16i or 440-16i); Mid: (940-8i or 540-8i or 440-8i)
32A-1	1 or 2	16	0	0	0	8	0	0	4	0	Y	Y	Y	Y	N	N	Y	Y	940-32i
32A-2	1 or 2										Y	Y	Y	Y	N	N	Y	Y	Front: (9350-16i or 4350-16i); Rear: (9350-16i or 4350-16i)
32A-3	1 or 2										Y	Y	Y	Y	N	N	Y	Y	Front: (940-16i or 540-16i or 440-16i); Rear: (940-16i or 540-16i or 440-16i)
32-2	1 or 2										Y	Y	Y	Y	N	N	Y	Y	(5350-8i or 9350-8i or 4350-8i) + Exp-44i
32-3	1 or 2										Y	Y	Y	Y	N	N	Y	Y	(940-8i or 540-8i or 440-8i) + Exp-44i
32-4	1 or 2										Y	Y	Y	Y	N	N	Y	Y	(9350-16i or 4350-16i) + Exp-44i
32-5	1 or 2										Y	Y	Y	Y	N	N	Y	Y	(940-16i or 540-16i or 440-16i) + Exp-44i
33-3	1 or 2	16	0	0	0	8	0	0	8	0	Y	Y	Y	Y	N	N	Y	Y	Front: (9350-16i or 4350-16i) + Exp-44i; Mid: Exp-44i
33-4	1 or 2										Y	Y	Y	Y	N	N	Y	Y	Front: (940-16i or 540-16i or 440-16i) + Exp-44i; Mid: Exp-44i
33A-1	1 or 2										Y	Y	Y	Y	Y	Y	Y	Y	940-32i
33A-2	1 or 2										Y	Y	Y	Y	Y	Y	Y	Y	Front: (9350-16i or 4350-16i); Rear: (9350-16i or 4350-16i)
33A-3	1 or 2										Y	Y	Y	Y	Y	Y	Y	Y	Front: (940-16i or 540-16i or 440-16i); Rear: (940-16i or 540-16i or 440-16i)

Details - 2.5-inch front drives supporting 12 slots (front & rear)

The following table details the configurations that use 2.5-inch front drives supporting 12 slots (front & rear).

Click to go to the [overview of the 2.5-inch front drive configurations](#).

Return to [Storage configurations](#).

Table 24. Details - 2.5-inch front drives supporting 12 slots (front & rear)

Config	CPUs	Front			Mid			Rear			Backplanes	M.2				7mm				Supported controllers										
		SAS/SATA	AnyBay	NVMe	3.5" SAS/SATA	2.5" SAS/SATA	2.5" NVMe	3.5" SAS/SATA	2.5" SAS/SATA	2.5" AnyBay		M.2 Non-RAID (SATA)	M.2 Non-RAID (NVMe)	M.2 + RAID adapter	M.2 RAID (NVMe)	7mm Non-RAID (SATA)	7mm Non-RAID (NVMe)	7mm + RAID adapter	7mm RAID (NVMe)											
10-1	2 only	8	0	0	0	0	0	0	0	0	1x 8x2.5" SAS/SATA (B8LU)	Y	Y	Y	Y	Y	Y	Y	Y	OB SATA										
10-2	1 or 2	8	0	0	0	0	0	0	0	0	1x 8x2.5" SAS/SATA (B8LU)	Y	Y	Y	Y	Y	Y	Y	Y	(5350-8i or 9350-8i or 4350-8i)										
10-3	1 or 2											Y	Y	Y	Y	Y	Y	Y	Y	(940-8i or 540-8i or 440-8i)										
10-4	1 or 2											Y	Y	Y	Y	Y	Y	Y	Y	(9350-16i or 4350-16i)										
10-5	1 or 2											Y	Y	Y	Y	Y	Y	Y	Y	(940-16i or 540-16i or 440-16i)										
10-6	2 only											Y	Y	Y	Y	Y	Y	Y	Y	(9350-8i CFF or 940-16i CFF or 5350-8i CFF or 440-16i CFF)										
												Y	Y	Y	Y	Y	Y	Y	Y	(9350-8i or 9350-8i or 4350-8i) + OB NVMe										
11F-1	2 only	0	8	0	0	0	0	0	0	0	1x 8x2.5" AnyBay G4 (BH8B)	N	Y	Y	Y	N	Y	Y	Y	(5350-8i or 9350-8i or 4350-8i) + OB NVMe										
11F-2	2 only	0	8	0	0	0	0	0	0	0	1x 8x2.5" AnyBay G4 (BH8B)	N	Y	Y	Y	N	Y	Y	Y	(940-8i or 540-8i or 440-8i) + OB NVMe										
11F-3	2 only											N	Y	Y	Y	N	Y	Y	Y	(9350-16i or 4350-16i) + OB NVMe										
11F-4	2 only											N	Y	Y	Y	N	Y	Y	Y	(940-16i or 540-16i or 440-16i) + OB NVMe										
												N	Y	Y	Y	N	Y	Y	Y	OB NVMe										
12F-1	2 only	0	0	8	0	0	0	0	0	0	1x 8x2.5" NVMe G4 (BH8D)	N	Y	Y	Y	N	Y	Y	Y	OB NVMe										
13-1	2 only	6	2	0	0	0	0	0	0	0	6xSAS/SATA+ 2xAnyBay G4 (BPL7)	Y	Y	Y	Y	Y	Y	Y	Y	(5350-8i or 9350-8i or 4350-8i) + OB NVMe										
13-2	2 only	6	2	0	0	0	0	0	0	0	6xSAS/SATA+ 2xAnyBay G4 (BPL7)	Y	Y	Y	Y	Y	Y	Y	Y	(940-8i or 540-8i or 440-8i) + OB NVMe										
14-1	2 only											16	0	0	0	0	0	0	0	0	2x 8x2.5" SAS/SATA (B8LU)	N	Y	Y	Y	N	Y	Y	Y	OB SATA
14-2	1 or 2											16	0	0	0	0	0	0	0	0	2x 8xAnyBay G4 (BH8B)	Y	Y	Y	Y	Y	Y	Y	Y	(9350-16i or 4350-16i)
14-3	1 or 2																					Y	Y	Y	Y	Y	Y	Y	Y	(940-16i or 540-16i or 440-16i)
14-6	2 only	Y	Y	Y	Y	Y	Y	Y	Y	(9350-16i CFF or 940-16i CFF or 440-16i CFF)																				
		N	Y	Y	Y	N	Y	Y	Y	940-16i Tri-mode																				
16-3	1 or 2	0	16	0	0	0	0	0	0	0	2x 8xAnyBay G4 (BH8B)	N	Y	Y	Y	N	Y	Y	Y	2x 940-8i Tri-mode										
16-4	1 or 2	8	8	0	0	0	0	0	0	0	1x 8x2.5" SAS/SATA (B8LU) + 1x 8x2.5" AnyBay G4 (BH8B)	N	Y	Y	Y	N	Y	Y	Y	(9350-16i or 4350-16i) + OB NVMe										
17F-2	2 only											N	Y	Y	Y	N	Y	Y	Y	(940-16i or 540-16i or 440-16i) + OB NVMe										
17F-3	2 only											N	Y	Y	Y	N	Y	Y	Y	(2x 5350-8i or 2x 9350-8i or 2x 4350-8i) + OB NVMe										
17F-4	2 only											N	Y	Y	Y	N	Y	Y	Y	2x (940-8i or 540-8i or 440-8i) + OB NVMe										
17F-5	2 only											N	Y	Y	Y	N	Y	Y	Y	2x (940-8i or 540-8i or 440-8i) + OB NVMe										

Config	CPUs	Front			Mid			Rear			Backplanes	M.2				7mm				Supported controllers
		SAS/SATA	AnyBay	NVMe	3.5" SAS/SATA	2.5" SAS/SATA	2.5" NVMe	3.5" SAS/SATA	2.5" SAS/SATA	2.5" AnyBay		M.2 Non-RAID (SATA)	M.2 Non-RAID (NVMe)	M.2 + RAID adapter	M.2 RAID (NVMe)	7mm Non-RAID (SATA)	7mm Non-RAID (NVMe)	7mm + RAID adapter	7mm RAID (NVMe)	
18F-1	2 only	8	0	8	0	0	0	0	0	0	1x 8x2.5" SAS/SATA (B8LU) + 1x 8x2.5" NVMe G4 (BH8D)	N	Y	Y	Y	N	Y	Y	Y	(5350-8i or 9350-8i or 4350-8i) + OB NVMe
18F-2	2 only											N	Y	Y	Y	N	Y	Y	Y	(940-8i or 540-8i or 440-8i) + OB NVMe
27A-2	1 or 2	16	0	0	0	4	0	0	0	0	Front: 2x 8x2.5" SAS/SATA (B8LU); Mid: 4x2.5" SAS/SATA (BCQL)	Y	Y	Y	Y	Y	Y	Y	Y	Front: (9350-16i or 4350-16i); Mid: (5350-8i or 9350-8i or 4350-8i)
31A-3	2 only	16	0	0	0	8	0	0	0	0	Front: 2x 8x2.5" SAS/SATA (B8LU); Mid: 2x 4x2.5" SAS/SATA (BCQL)	Y	Y	Y	Y	Y	Y	Y	Y	Front: (940-16i or 540-16i or 440-16i); Mid: (940-8i or 540-8i or 440-8i)

Field upgrades

The SR665 V3 is orderable without drive bays, allowing you to add a backplane, cabling and controllers as field upgrades. The server also supports upgrading some configurations by adding additional front drive bays (for example, upgrading from 8 to 16x 2.5-inch drive bays).

To add drive bays you will need to order both drive backplanes and cable kits. Backplane kits do not include cables.

The upgrades are listed as follows:

- [3.5-inch chassis drive bay upgrades](#)
- [2.5-inch chassis drive bay upgrades](#)
- [Upgrades to Retimer adapters](#)
- [Upgrades to an Internal \(CFF\) HBA/RAID adapter](#)

For more information about the backplane kits and cable kits, see the Lenovo server options site: https://serveroption.lenovo.com/cable_kit_options/

3.5-inch chassis drive bay upgrades

The table below lists the backplane kits and cable kits needed to build one of the supported 3.5-inch chassis configurations.

Tip: The configurations each have a letter that matches the configurations listed in the [Storage configurations](#) section.

Table 25. Drive bay field upgrade for the 3.5-inch chassis (Blue = SAS/SATA, Purple = AnyBay, Red = NVMe)

Cfg	Front			Mid			Rear			Backplane and cable kits required (all required)
	SAS/SATA	Any Bay	NVMe	3.5" SAS	2.5" SAS	2.5" NVMe	3.5" SAS	2.5" SAS	2.5" Any	

Cfg	Front			Mid			Rear			Backplane and cable kits required (all required)
	SAS/SATA	Any Bay	NVMe	3.5" SAS	2.5" SAS	2.5" NVMe	3.5" SAS	2.5" SAS	2.5" Any	
1	8	0	0	0	0	0	0	0	0	<ul style="list-style-type: none"> • 4XH7A60932, ThinkSystem SR650 V2/SR665 8x3.5" SAS/SATA Backplane Option Kit • 4X97A85163, ThinkSystem SR665 V3 3.5" Chassis Front Backplane SAS/SATA Cable Option Kit
2	12	0	0	0	0	0	0	0	0	<ul style="list-style-type: none"> • 4XH7A60929, ThinkSystem V2/V3 2U 12x3.5" SAS/SATA Backplane Option Kit • 4X97A85163, ThinkSystem SR665 V3 3.5" Chassis Front Backplane SAS/SATA Cable Option Kit
2A	12	0	0	0	0	0	0	0	0	<ul style="list-style-type: none"> • 4XH7A86133, ThinkSystem SR665 V3/SR655 V3 12x3.5" Expander Backplane Option Kit • 4X97A85179, ThinkSystem SR665 V3 12x3.5"+24x2.5" Expander Backplane Cable Option Kit
3	8	4	0	0	0	0	0	0	0	<ul style="list-style-type: none"> • 4XH7A85900, ThinkSystem SR665 V3 12x3.5" AnyBay Backplane Option Kit • 4X97A85164, ThinkSystem SR665 V3 3.5" Chassis Front Backplane AnyBay Cable Option Kit
3A	8	0	4	0	0	0	0	0	0	<ul style="list-style-type: none"> • 4XH7A85900, ThinkSystem SR665 V3 12x3.5" AnyBay Backplane Option Kit • 4X97A85164, ThinkSystem SR665 V3 3.5" Chassis Front Backplane AnyBay Cable Option Kit
4	12	0	0	0	0	0	2	0	0	<ul style="list-style-type: none"> • 4XH7A60929, ThinkSystem V2/V3 2U 12x3.5" SAS/SATA Backplane Option Kit • 4XH7A60940, ThinkSystem SR650 V2/SR665 Rear 2x3.5" SAS/SATA Backplane Option Kit • 4X97A85163, ThinkSystem SR665 V3 3.5" Chassis Front Backplane SAS/SATA Cable Option Kit • 4X97A85165, ThinkSystem SR665 V3 3.5" Chassis Rear Backplane SAS/SATA Cable Option Kit
4A	12	0	0	0	0	0	2	0	0	<ul style="list-style-type: none"> • 4XH7A86133, ThinkSystem SR665 V3/SR655 V3 12x3.5" Expander Backplane Option Kit • 4XH7A60940, ThinkSystem SR650 V2/SR665 Rear 2x3.5" SAS/SATA Backplane Option Kit • 4X97A85179, ThinkSystem SR665 V3 12x3.5"+24x2.5" Expander Backplane Cable Option Kit • 4X97A85165, ThinkSystem SR665 V3 3.5" Chassis Rear Backplane SAS/SATA Cable Option Kit
5	12	0	0	0	0	0	4	0	0	<ul style="list-style-type: none"> • 4XH7A60929, ThinkSystem V2/V3 2U 12x3.5" SAS/SATA Backplane Option Kit • 4XH7A60939, ThinkSystem V2/V3 2U Rear 4x3.5" SAS/SATA Rear Backplane Option Kit • 4X97A85163, ThinkSystem SR665 V3 3.5" Chassis Front Backplane SAS/SATA Cable Option Kit • 4X97A85165, ThinkSystem SR665 V3 3.5" Chassis Rear Backplane SAS/SATA Cable Option Kit
5A	12	0	0	0	0	0	4	0	0	<ul style="list-style-type: none"> • 4XH7A86133, ThinkSystem SR665 V3/SR655 V3 12x3.5" Expander Backplane Option Kit • 4XH7A60939, ThinkSystem V2/V3 2U Rear 4x3.5" SAS/SATA Rear Backplane Option Kit • 4X97A85179, ThinkSystem SR665 V3 12x3.5"+24x2.5" Expander Backplane Cable Option Kit • 4X97A85165, ThinkSystem SR665 V3 3.5" Chassis Rear Backplane SAS/SATA Cable Option Kit

Cfg	Front			Mid			Rear			Backplane and cable kits required (all required)
	SAS/SATA	Any Bay	NVMe	3.5" SAS	2.5" SAS	2.5" NVMe	3.5" SAS	2.5" SAS	2.5" Any	
6	12	0	0	4	0	0	0	0	0	<ul style="list-style-type: none"> • 4XH7A60929, ThinkSystem V2/V3 2U 12x3.5" SAS/SATA Backplane Option Kit • 4XH7A85892, ThinkSystem SR665 V3 Middle 4x3.5" SAS/SATA Backplane Option Kit • 4X97A85163, ThinkSystem SR665 V3 3.5" Chassis Front Backplane SAS/SATA Cable Option Kit • 4X97A85166, ThinkSystem SR665 V3 3.5" Chassis Middle Backplane SAS/SATA Cable Option Kit
6A	12	0	0	0	4	0	0	0	0	<ul style="list-style-type: none"> • 4XH7A60929, ThinkSystem V2/V3 2U 12x3.5" SAS/SATA Backplane Option Kit • 4XH7A85890, ThinkSystem SR665 V3 Middle 4x2.5" SAS/SATA Backplane Option Kit • 4X97A85163, ThinkSystem SR665 V3 3.5" Chassis Front Backplane SAS/SATA Cable Option Kit • 4X97A85175, ThinkSystem SR665 V3 2.5" Chassis Middle Backplane SAS/SATA Cable Option Kit
7B	12	0	0	0	0	0	0	4	0	<ul style="list-style-type: none"> • 4XH7A60929, ThinkSystem V2/V3 2U 12x3.5" SAS/SATA Backplane Option Kit • 4XH7A60938, ThinkSystem V3 2U 4x2.5" SAS/SATA Rear Backplane Option Kit • 4X97A85163, ThinkSystem SR665 V3 3.5" Chassis Front Backplane SAS/SATA Cable Option Kit • 4X97A85173, ThinkSystem SR665 V3 2.5" Chassis Rear Backplane SAS/SATA Cable Option Kit
8	12	0	0	4	0	0	4	0	0	<ul style="list-style-type: none"> • 4XH7A60929, ThinkSystem V2/V3 2U 12x3.5" SAS/SATA Backplane Option Kit • 4XH7A85892, ThinkSystem SR665 V3 Middle 4x3.5" SAS/SATA Backplane Option Kit • 4XH7A60939, ThinkSystem V2/V3 2U Rear 4x3.5" SAS/SATA Rear Backplane Option Kit • 4X97A85163, ThinkSystem SR665 V3 3.5" Chassis Front Backplane SAS/SATA Cable Option Kit • 4X97A85166, ThinkSystem SR665 V3 3.5" Chassis Middle Backplane SAS/SATA Cable Option Kit • 4X97A85165, ThinkSystem SR665 V3 3.5" Chassis Rear Backplane SAS/SATA Cable Option Kit
8A	12	0	0	4	0	0	4	0	0	<ul style="list-style-type: none"> • 4XH7A86133, ThinkSystem SR665 V3/SR655 V3 12x3.5" Expander Backplane Option Kit • 4XH7A85892, ThinkSystem SR665 V3 Middle 4x3.5" SAS/SATA Backplane Option Kit • 4XH7A60939, ThinkSystem V2/V3 2U Rear 4x3.5" SAS/SATA Rear Backplane Option Kit • 4X97A85179, ThinkSystem SR665 V3 12x3.5"+24x2.5" Expander Backplane Cable Option Kit • 4X97A85166, ThinkSystem SR665 V3 3.5" Chassis Middle Backplane SAS/SATA Cable Option Kit • 4X97A85165, ThinkSystem SR665 V3 3.5" Chassis Rear Backplane SAS/SATA Cable Option Kit
9	12	0	0	0	0	8	0	0	0	<ul style="list-style-type: none"> • 4XH7A60929, ThinkSystem V2/V3 2U 12x3.5" SAS/SATA Backplane Option Kit • 2x 4XH7A85891, ThinkSystem SR665 V3 Middle 4x2.5" NVMe Backplane Option Kit • 4X97A85163, ThinkSystem SR665 V3 3.5" Chassis Front Backplane SAS/SATA Cable Option Kit • 2x 4X97A85176, ThinkSystem SR665 V3 2.5" Chassis Middle Backplane NVMe Cable Option Kit

When adding drive bays, you will also need to add the appropriate storage controller(s). Consult the tables in the [Storage configurations](#) section to determine what controller sections are supported and what additional controllers you will need. Controllers are described in the [Controllers for internal storage](#) section.

2.5-inch chassis drive bay upgrades

The table below lists the backplane kits and cable kits needed to build one of the supported 2.5-inch chassis configurations.

Tip: The configurations each have a letter that matches the configurations listed in the [Storage configurations](#) section.

Note: Front drive cable kits are based on the location of the backplane in the server. The three backplane locations are BP1, BP2 and BP3 as shown in the following figure.

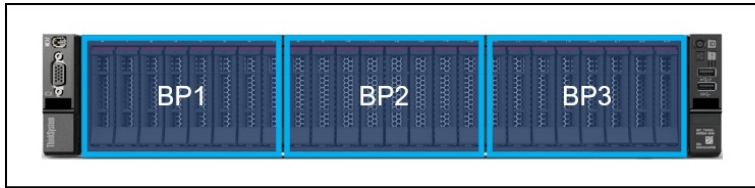

Figure 12. Backplane numbering

Table 26. Drive bay field upgrade for the 2.5-inch chassis (Blue = SAS/SATA, Purple = AnyBay, Red = NVMe)

Cfg	Front			Mid			Rear			Backplane and cable kits required (all required)
	SAS/SATA	Any Bay	NVMe	3.5" SAS	2.5" SAS	2.5" NVMe	3.5" SAS	2.5" SAS	2.5" Any	
10	8	0	0	0	0	0	0	0	0	<ul style="list-style-type: none"> 4XH7A60930, ThinkSystem V3 2U 8x2.5" SAS/SATA Backplane Option Kit 4X97A85168, ThinkSystem SR665 V3 2.5" Chassis Front BP1 SAS/SATA Cable Option Kit
11	0	8	0	0	0	0	0	0	0	<ul style="list-style-type: none"> 4XH7A85901, ThinkSystem V3 2U 8x2.5" AnyBay Backplane Option Kit 4X97A85167, ThinkSystem SR665 V3 2.5" Chassis Front AnyBay BP1 Cable Option Kit
12	0	0	8	0	0	0	0	0	0	<ul style="list-style-type: none"> 4XH7A82910, ThinkSystem V3 2U 8x2.5" NVMe Backplane Option Kit 4X97A87124, ThinkSystem SR665 V3 2.5" Chassis Front BP1 AnyBay Cable Option Kit (CPU Balance)
13	6	2	0	0	0	0	0	0	0	<ul style="list-style-type: none"> 4XH7A85901, ThinkSystem V3 2U 8x2.5" AnyBay Backplane Option Kit 4X97A85167, ThinkSystem SR665 V3 2.5" Chassis Front AnyBay BP1 Cable Option Kit
14	16	0	0	0	0	0	0	0	0	<ul style="list-style-type: none"> 2x 4XH7A60930, ThinkSystem V3 2U 8x2.5" SAS/SATA Backplane Option Kit 4X97A85168, ThinkSystem SR665 V3 2.5" Chassis Front BP1 SAS/SATA Cable Option Kit 4X97A85170, ThinkSystem SR665 V3 2.5" Chassis Front BP2 SAS/SATA Cable Option Kit

Cfg	Front			Mid			Rear			Backplane and cable kits required (all required)
	SAS/SATA	Any Bay	NVMe	3.5" SAS	2.5" SAS	2.5" NVMe	3.5" SAS	2.5" SAS	2.5" Any	
15	0	8	8	0	0	0	0	0	0	<ul style="list-style-type: none"> • 4XH7A85901, ThinkSystem V3 2U 8x2.5" AnyBay Backplane Option Kit • 4XH7A82910, ThinkSystem V3 2U 8x2.5" NVMe Backplane Option Kit • 4X97A85167, ThinkSystem SR665 V3 2.5" Chassis Front AnyBay BP1 Cable Option Kit • 4X97A86789, ThinkSystem SR665 V3 2.5" Chassis Front BP2 AnyBay Cable Option Kit (CPU Balance)
16	0	0	16	0	0	0	0	0	0	<ul style="list-style-type: none"> • 2x 4XH7A82910, ThinkSystem V3 2U 8x2.5" NVMe Backplane Option Kit • 4X97A87124, ThinkSystem SR665 V3 2.5" Chassis Front BP1 AnyBay Cable Option Kit (CPU Balance) • 4X97A86789, ThinkSystem SR665 V3 2.5" Chassis Front BP2 AnyBay Cable Option Kit (CPU Balance)
17	8	8	0	0	0	0	0	0	0	<ul style="list-style-type: none"> • 4XH7A60930, ThinkSystem V3 2U 8x2.5" SAS/SATA Backplane Option Kit • 4XH7A85901, ThinkSystem V3 2U 8x2.5" AnyBay Backplane Option Kit • 4XH7A85901, ThinkSystem V3 2U 8x2.5" AnyBay Backplane Option Kit • 4X97A85169, ThinkSystem SR665 V3 2.5" Chassis Front AnyBay BP2 Cable Option Kit
18	8	0	8	0	0	0	0	0	0	<ul style="list-style-type: none"> • 4XH7A60930, ThinkSystem V3 2U 8x2.5" SAS/SATA Backplane Option Kit • 4XH7A82910, ThinkSystem V3 2U 8x2.5" NVMe Backplane Option Kit • 4XH7A85901, ThinkSystem V3 2U 8x2.5" AnyBay Backplane Option Kit • 4X97A86789, ThinkSystem SR665 V3 2.5" Chassis Front BP2 AnyBay Cable Option Kit (CPU Balance)
19	12	0	4	0	0	0	0	0	0	<ul style="list-style-type: none"> • 4XH7A60930, ThinkSystem V3 2U 8x2.5" SAS/SATA Backplane Option Kit • 4XH7A82910, ThinkSystem V3 2U 8x2.5" NVMe Backplane Option Kit • 4XH7A85901, ThinkSystem V3 2U 8x2.5" AnyBay Backplane Option Kit • 4X97A86789, ThinkSystem SR665 V3 2.5" Chassis Front BP2 AnyBay Cable Option Kit (CPU Balance)
20	16	8	0	0	0	0	0	0	0	<ul style="list-style-type: none"> • 2x 4XH7A60930, ThinkSystem V3 2U 8x2.5" SAS/SATA Backplane Option Kit • 4X97A85168, ThinkSystem SR665 V3 2.5" Chassis Front BP1 SAS/SATA Cable Option Kit • 4X97A85170, ThinkSystem SR665 V3 2.5" Chassis Front BP2 SAS/SATA Cable Option Kit
21	16	0	8	0	0	0	0	0	0	<ul style="list-style-type: none"> • 2x 4XH7A60930, ThinkSystem V3 2U 8x2.5" SAS/SATA Backplane Option Kit • 4X97A85168, ThinkSystem SR665 V3 2.5" Chassis Front BP1 SAS/SATA Cable Option Kit • 4X97A85170, ThinkSystem SR665 V3 2.5" Chassis Front BP2 SAS/SATA Cable Option Kit • 4X97A85171, ThinkSystem SR665 V3 2.5" Chassis Front AnyBay BP3 Cable Option Kit

Cfg	Front			Mid			Rear			Backplane and cable kits required (all required)
	SAS/SATA	Any Bay	NVMe	3.5" SAS	2.5" SAS	2.5" NVMe	3.5" SAS	2.5" SAS	2.5" Any	
22	24	0	0	0	0	0	0	0	0	<ul style="list-style-type: none"> • 3x 4XH7A60930, ThinkSystem V3 2U 8x2.5" SAS/SATA Backplane Option Kit • 4X97A85168, ThinkSystem SR665 V3 2.5" Chassis Front BP1 SAS/SATA Cable Option Kit • 4X97A85170, ThinkSystem SR665 V3 2.5" Chassis Front BP2 SAS/SATA Cable Option Kit • 4X97A85172, ThinkSystem SR665 V3 2.5" Chassis Front BP3 SAS/SATA Cable Option Kit
22A	24	0	0	0	0	0	0	0	0	<ul style="list-style-type: none"> • 4XH7A86134, ThinkSystem SR665 V3/SR655 V3 24x2.5" Expander Backplane Option Kit • 4X97A85179, ThinkSystem SR665 V3 12x3.5"+24x2.5" Expander Backplane Cable Option Kit
23	0	0	24	0	0	0	0	0	0	<ul style="list-style-type: none"> • 3x 4XH7A82910, ThinkSystem V3 2U 8x2.5" NVMe Backplane Option Kit • 4X97A87124, ThinkSystem SR665 V3 2.5" Chassis Front BP1 AnyBay Cable Option Kit (CPU Balance) • 4X97A86789, ThinkSystem SR665 V3 2.5" Chassis Front BP2 AnyBay Cable Option Kit (CPU Balance) • 4X97A85171, ThinkSystem SR665 V3 2.5" Chassis Front AnyBay BP3 Cable Option Kit
24	0	8	16	0	0	0	0	0	0	<ul style="list-style-type: none"> • 4XH7A85901, ThinkSystem V3 2U 8x2.5" AnyBay Backplane Option Kit • 2x 4XH7A82910, ThinkSystem V3 2U 8x2.5" NVMe Backplane Option Kit • 4X97A85167, ThinkSystem SR665 V3 2.5" Chassis Front AnyBay BP1 Cable Option Kit • 4X97A86789, ThinkSystem SR665 V3 2.5" Chassis Front BP2 AnyBay Cable Option Kit (CPU Balance) • 4X97A85171, ThinkSystem SR665 V3 2.5" Chassis Front AnyBay BP3 Cable Option Kit
24B	8	0	16	0	0	0	0	0	0	<ul style="list-style-type: none"> • 4XH7A60930, ThinkSystem V3 2U 8x2.5" SAS/SATA Backplane Option Kit • 2x 4XH7A82910, ThinkSystem V3 2U 8x2.5" NVMe Backplane Option Kit • 4XH7A85901, ThinkSystem V3 2U 8x2.5" AnyBay Backplane Option Kit • 4X97A86789, ThinkSystem SR665 V3 2.5" Chassis Front BP2 AnyBay Cable Option Kit (CPU Balance) • 4X97A85171, ThinkSystem SR665 V3 2.5" Chassis Front AnyBay BP3 Cable Option Kit
25	16	8	0	0	0	0	0	4	0	<ul style="list-style-type: none"> • 2x 4XH7A60930, ThinkSystem V3 2U 8x2.5" SAS/SATA Backplane Option Kit • 4XH7A85901, ThinkSystem V3 2U 8x2.5" AnyBay Backplane Option Kit • 4XH7A60938, ThinkSystem V3 2U 4x2.5" SAS/SATA Rear Backplane Option Kit • 4X97A85168, ThinkSystem SR665 V3 2.5" Chassis Front BP1 SAS/SATA Cable Option Kit • 4X97A85170, ThinkSystem SR665 V3 2.5" Chassis Front BP2 SAS/SATA Cable Option Kit • 4X97A85171, ThinkSystem SR665 V3 2.5" Chassis Front AnyBay BP3 Cable Option Kit • 4X97A85173, ThinkSystem SR665 V3 2.5" Chassis Rear Backplane SAS/SATA Cable Option Kit

Cfg	Front			Mid			Rear			Backplane and cable kits required (all required)
	SAS/SATA	Any Bay	NVMe	3.5" SAS	2.5" SAS	2.5" NVMe	3.5" SAS	2.5" SAS	2.5" Any	
26	24	0	0	0	0	0	0	4	0	<ul style="list-style-type: none"> • 3x 4XH7A60930, ThinkSystem V3 2U 8x2.5" SAS/SATA Backplane Option Kit • 4XH7A60938, ThinkSystem V3 2U 4x2.5" SAS/SATA Rear Backplane Option Kit • 4X97A85168, ThinkSystem SR665 V3 2.5" Chassis Front BP1 SAS/SATA Cable Option Kit • 4X97A85170, ThinkSystem SR665 V3 2.5" Chassis Front BP2 SAS/SATA Cable Option Kit • 4X97A85172, ThinkSystem SR665 V3 2.5" Chassis Front BP3 SAS/SATA Cable Option Kit • 4X97A85173, ThinkSystem SR665 V3 2.5" Chassis Rear Backplane SAS/SATA Cable Option Kit
26A	24	0	0	0	0	0	0	4	0	<ul style="list-style-type: none"> • 4XH7A86134, ThinkSystem SR665 V3/SR655 V3 24x2.5" Expander Backplane Option Kit • 4XH7A60938, ThinkSystem V3 2U 4x2.5" SAS/SATA Rear Backplane Option Kit • 4X97A85179, ThinkSystem SR665 V3 12x3.5"+ 24x2.5" Expander Backplane Cable Option Kit • 4X97A85173, ThinkSystem SR665 V3 2.5" Chassis Rear Backplane SAS/SATA Cable Option Kit
27	24	0	0	0	4	0	0	0	0	<ul style="list-style-type: none"> • 3x 4XH7A60930, ThinkSystem V3 2U 8x2.5" SAS/SATA Backplane Option Kit • 4XH7A85890, ThinkSystem SR665 V3 Middle 4x2.5" SAS/SATA Backplane Option Kit • 4X97A85168, ThinkSystem SR665 V3 2.5" Chassis Front BP1 SAS/SATA Cable Option Kit • 4X97A85170, ThinkSystem SR665 V3 2.5" Chassis Front BP2 SAS/SATA Cable Option Kit • 4X97A85172, ThinkSystem SR665 V3 2.5" Chassis Front BP3 SAS/SATA Cable Option Kit • 4X97A85175, ThinkSystem SR665 V3 2.5" Chassis Middle Backplane SAS/SATA Cable Option Kit
29	24	0	0	0	0	0	0	8	0	<ul style="list-style-type: none"> • 3x 4XH7A60930, ThinkSystem V3 2U 8x2.5" SAS/SATA Backplane Option Kit • 4XH7A60941, ThinkSystem SR650 V2/SR665 Rear 8x2.5" SAS/SATA Backplane Option Kit • 4X97A85168, ThinkSystem SR665 V3 2.5" Chassis Front BP1 SAS/SATA Cable Option Kit • 4X97A85170, ThinkSystem SR665 V3 2.5" Chassis Front BP2 SAS/SATA Cable Option Kit • 4X97A85172, ThinkSystem SR665 V3 2.5" Chassis Front BP3 SAS/SATA Cable Option Kit • 4X97A85173, ThinkSystem SR665 V3 2.5" Chassis Rear Backplane SAS/SATA Cable Option Kit
29A	24	0	0	0	0	0	0	8	0	<ul style="list-style-type: none"> • 4XH7A86134, ThinkSystem SR665 V3/SR655 V3 24x2.5" Expander Backplane Option Kit • 4XH7A60941, ThinkSystem SR650 V2/SR665 Rear 8x2.5" SAS/SATA Backplane Option Kit • 4X97A85179, ThinkSystem SR665 V3 12x3.5"+ 24x2.5" Expander Backplane Cable Option Kit • 4X97A85173, ThinkSystem SR665 V3 2.5" Chassis Rear Backplane SAS/SATA Cable Option Kit

Cfg	Front			Mid			Rear			Backplane and cable kits required (all required)
	SAS/SATA	Any Bay	NVMe	3.5" SAS	2.5" SAS	2.5" NVMe	3.5" SAS	2.5" SAS	2.5" Any	
30	0	0	24	0	0	8	0	0	0	<ul style="list-style-type: none"> • 3x 4XH7A82910, ThinkSystem V3 2U 8x2.5" NVMe Backplane Option Kit • 2x 4XH7A85891, ThinkSystem SR665 V3 Middle 4x2.5" NVMe Backplane Option Kit • 4X97A87124, ThinkSystem SR665 V3 2.5" Chassis Front BP1 AnyBay Cable Option Kit (CPU Balance) • 4X97A86789, ThinkSystem SR665 V3 2.5" Chassis Front BP2 AnyBay Cable Option Kit (CPU Balance) • 4X97A85171, ThinkSystem SR665 V3 2.5" Chassis Front AnyBay BP3 Cable Option Kit • 2x 4X97A85176, ThinkSystem SR665 V3 2.5" Chassis Middle Backplane NVMe Cable Option Kit
31	24	0	0	0	8	0	0	0	0	<ul style="list-style-type: none"> • 3x 4XH7A60930, ThinkSystem V3 2U 8x2.5" SAS/SATA Backplane Option Kit • 2x 4XH7A85890, ThinkSystem SR665 V3 Middle 4x2.5" SAS/SATA Backplane Option Kit • 4X97A85168, ThinkSystem SR665 V3 2.5" Chassis Front BP1 SAS/SATA Cable Option Kit • 4X97A85170, ThinkSystem SR665 V3 2.5" Chassis Front BP2 SAS/SATA Cable Option Kit • 4X97A85172, ThinkSystem SR665 V3 2.5" Chassis Front BP3 SAS/SATA Cable Option Kit • 2x 4X97A85175, ThinkSystem SR665 V3 2.5" Chassis Middle Backplane SAS/SATA Cable Option Kit
32	24	0	0	0	8	0	0	4	0	<ul style="list-style-type: none"> • 3x 4XH7A60930, ThinkSystem V3 2U 8x2.5" SAS/SATA Backplane Option Kit • 2x 4XH7A85890, ThinkSystem SR665 V3 Middle 4x2.5" SAS/SATA Backplane Option Kit • 4XH7A60938, ThinkSystem V3 2U 4x2.5" SAS/SATA Rear Backplane Option Kit • 4X97A85168, ThinkSystem SR665 V3 2.5" Chassis Front BP1 SAS/SATA Cable Option Kit • 4X97A85170, ThinkSystem SR665 V3 2.5" Chassis Front BP2 SAS/SATA Cable Option Kit • 4X97A85172, ThinkSystem SR665 V3 2.5" Chassis Front BP3 SAS/SATA Cable Option Kit • 2x 4X97A85175, ThinkSystem SR665 V3 2.5" Chassis Middle Backplane SAS/SATA Cable Option Kit • 4X97A85173, ThinkSystem SR665 V3 2.5" Chassis Rear Backplane SAS/SATA Cable Option Kit
33	24	0	0	0	8	0	0	8	0	<ul style="list-style-type: none"> • 3x 4XH7A60930, ThinkSystem V3 2U 8x2.5" SAS/SATA Backplane Option Kit • 2x 4XH7A85890, ThinkSystem SR665 V3 Middle 4x2.5" SAS/SATA Backplane Option Kit • 4XH7A60941, ThinkSystem SR650 V2/SR665 Rear 8x2.5" SAS/SATA Backplane Option Kit • 4X97A85168, ThinkSystem SR665 V3 2.5" Chassis Front BP1 SAS/SATA Cable Option Kit • 4X97A85170, ThinkSystem SR665 V3 2.5" Chassis Front BP2 SAS/SATA Cable Option Kit • 4X97A85172, ThinkSystem SR665 V3 2.5" Chassis Front BP3 SAS/SATA Cable Option Kit • 2x 4X97A85175, ThinkSystem SR665 V3 2.5" Chassis Middle Backplane SAS/SATA Cable Option Kit • 4X97A85173, ThinkSystem SR665 V3 2.5" Chassis Rear Backplane SAS/SATA Cable Option Kit

When adding drive bays, you will also need to add the appropriate storage controller(s). Consult the tables in the [Storage configurations](#) section to determine what controller sections are supported and what additional controllers you will need. Controllers are described in the [Controllers for internal storage](#) section.

Upgrades to Retimer adapters

If you are upgrading to a configuration that includes a Retimer adapter (see the Detailed tables in the [Storage configurations](#) section), then you will need to also order one of the following cable kits.

Table 27. Cable kits when upgrading to a Retimer configuration

Part number	Description	Quantity required
4X97A85860	ThinkSystem SR665 V3 32x2.5" PCIe Gen4 NVME Retimer Cable Option Kit	1
4X97A85859	ThinkSystem SR665 V3 24x2.5" PCIe Gen4 NVME Retimer Cable Option Kit	1

Upgrades to an Internal (CFF) HBA/RAID adapter

If you want to add an internal (CFF) storage adapter (HBA, RAID adapter or SAS expander) to a configuration, you will need to order the cable kit as listed in the following table. Suitable upgrades are either replacing an existing adapter in a rear PCIe slot, or adding the CFF adapter to a server without any storage adapter installed.

The cable kit to order is listed in the following table.

Table 28. Cable kit when upgrading to an Internal HBA/RAID adapter

Part number	Description	Quantity required
4X97A85177	ThinkSystem SR665 V3 Internal HBA/RAID Adapter Cable Option Kit	1

RAID flash power module (supercap) support

If you plan to add one of the RAID adapters that includes a RAID flash power module (supercap) as a field upgrade, then you may also need to order a Supercap installation kit for the supercap, depending on the location where the supercap will be installed. For CTO orders, the components needed are automatically derived when you select the RAID adapter.

The adapters that this applies to are as follows:

- Any supported RAID 9350 adapter
- Any supported RAID 940 adapter

The location of the supercaps depends on the mid-chassis drive cage used in the server, as shown in the following table.

Table 29. Supercap support

Mid drive cage	Supercaps supported	Location of supercaps	Supercap holder
No mid drive cage	4	Mounted on the air baffle	Not needed
2.5-inch drives	2	Mounted on the left side of the mid drive cage	Integrated into the left side of the 2.5-inch mid drive cage
3.5-inch drives	1	Mounted under the system fan cage	Included with ThinkSystem SR665 V3 Middle 4x3.5" SAS/SATA Backplane Option Kit (4XH7A85892) or order separately (see below)

For 3.5-inch drive bay configurations, if the server already has 3.5-inch mid-chassis drive bays, then the supercap holder is already present under the system fan cages. If you plan to add 3.5-inch mid-chassis drive bays by adding ThinkSystem SR665 V3 Middle 4x3.5" SAS/SATA Backplane Option Kit (4XH7A85892), then the supercap holder is part of the option kit.

7mm drives

The SR665 V3 supports two 7mm drives, either both SATA or both NVMe, at the rear of the server. These drives go in place of either PCIe slot 3 (Riser 1) or PCIe slot 6 (Riser 2) as shown in the following figure.

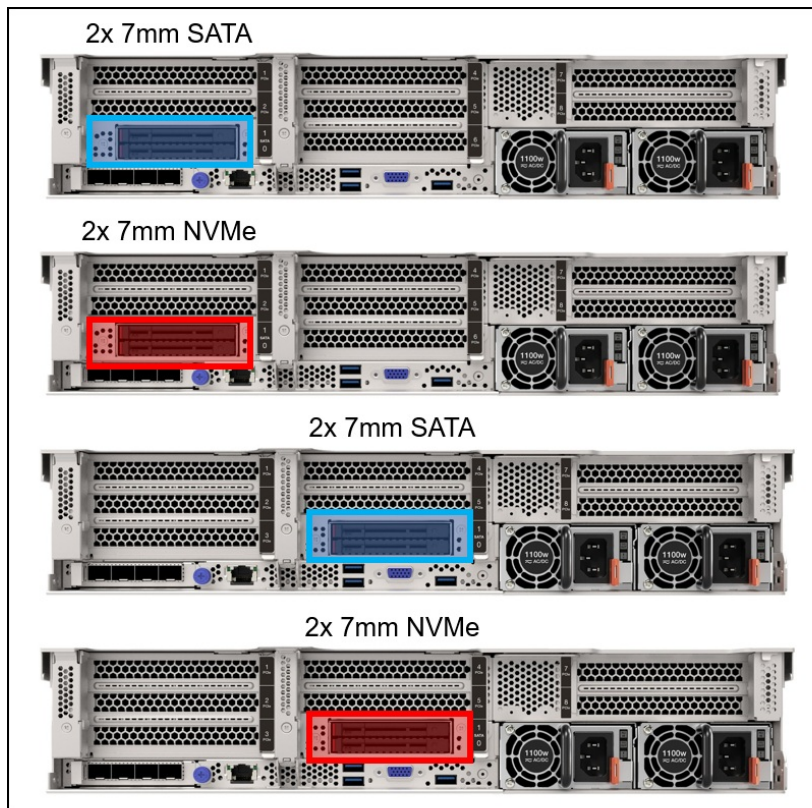

Figure 13. Rear 7mm drive bay configurations

For CTO orders, the configuration includes the drive bays and the cage the drive bays are mounted on to. The cage required depends on where the 7mm drives are located (Riser 1 or Riser 2) and whether there are PCIe slots above the 7mm drive bays. The following table lists the ordering information.

Tip for 4x 3.5-inch rear drives: If you wish to configure 4x 3.5-inch rear drives plus 7mm drives in a CTO configuration, the 7mm drives will install in slot 6. You should specify riser card BLKP for Riser 1 and then leave Riser 2 without a riser selected.

Table 30. CTO feature codes for 7mm drives

Feature code	Description	Maximum supported
Backplane - 7mm drives		
BU0N	ThinkSystem 7mm SATA/NVMe 2-Bay Rear Enablement Kit v2	1
B8P3	ThinkSystem 2U 7mm Drive Kit w/ NVMe RAID	1
Hardware RAID support for ThinkSystem 7mm SATA/NVMe 2-Bay Rear Enablement Kit v2 (BU0N)		
BT7N	ThinkSystem RAID 5350-8i for M.2/7mm SATA Boot Enablement	1
BT7P	ThinkSystem RAID 540-8i for M.2/7mm NVMe Boot Enablement	1

The use of the 7mm rear drive bays has the following configuration rules:

- The 7mm rear drive kit is supported in either slot 3 or slot 6 but not both at the same time.
- M.2 and 7mm are mutually exclusive: they are not supported together in the same configuration
- For ThinkSystem 7mm SATA/NVMe 2-Bay Rear Enablement Kit v2 (feature BU0N):
 - The 7mm drive bays support either SATA drives or NVMe drives but not both. You specify SATA or NVMe in the configurator using feature codes BTTV (SATA) or BTTW (NVMe).
 - If RAID support is required, select feature code BS7A in the configurator to enable RAID
 - The support of RAID-1 with the 7mm drives requires an additional RAID adapter that is installed in PCIe slot 2 or slot 3:
 - RAID support for 7mm SATA drives requires a RAID 5350-8i adapter (feature BT7N)
 - RAID support for 7mm NVMe drives requires a RAID 540-8i adapter operating in Tri-Mode (feature BT7P)
 - The RAID adapter used for 7mm drive support cannot be configured for use with other drive bays (not even with M.2)
 - If RAID support is not required, the 7mm drives connect to an onboard port; No additional adapter is required
- For ThinkSystem 2U 7mm Drive Kit w/ NVMe RAID (feature B8P3)
 - The adapter only supports NVMe drives
 - RAID functionality is integrated into the M.2 adapter using a Marvell 88NR2241 NVMe RAID Controller

7mm drive field upgrades

For field upgrades, using the following ordering information. The kits include two cages for use depending on your PCIe slot configuration. The cages are for either Riser 1 or Riser 2. The part numbers also include the cables necessary to connect the 7mm backplane to either the system board or RAID adapter.

Table 31. Field upgrade part numbers for 7mm drives

Part number	Description	Purpose
7mm Enablement Kits		
4XH7A85898	ThinkSystem SR665 V3 Rear 2x7mm SATA/NVMe Enablement Kit <ul style="list-style-type: none"> • 2-bay hot-swap drive enclosure • 2FH+7mm SSD Riser Cage (with 2 FH PCIe slots) • 7mm SSD Riser Cage (without PCIe slots) • 2x 7mm drive bay fillers • Signal and power cables for onboard connections 	7mm drive bays for SATA or NVMe drive support with no RAID support (does not include cables needed for RAID support with a separate adapter)
4XH7A85899	ThinkSystem SR665 V3 Rear 2x7mm SATA/NVMe RAID Enablement Kit <ul style="list-style-type: none"> • 2-bay SATA hot-swap drive enclosure • 2FH+7mm SSD Riser Cage (with 2 FH PCIe slots) • 7mm SSD Riser Cage (without PCIe slots) • 2x 7mm drive bay fillers • Signal and power cables for RAID adapter connectivity 	7mm drive bays for SATA or NVMe drives, plus cables for use with a RAID adapter. Requires a separate RAID adapter for RAID support.
4XH7A88742	ThinkSystem SR665 V3 Rear 2x7mm NVMe RAID Enablement Kit <ul style="list-style-type: none"> • 2-bay hot-swap drive enclosure • 2FH+7mm SSD Riser Cage (with 2 FH PCIe slots) • 7mm SSD Riser Cage (without PCIe slots) • 2x 7mm drive bay fillers • Signal and power cables for onboard connections 	7mm drive bays for NVMe drive support. RAID support is integrated into the adapter using an onboard Marvell 88NR2241 NVMe RAID controller.
RAID adapters for optional 7mm HW RAID support (for use with 4XH7A85899)		
4Y37A72482	ThinkSystem RAID 5350-8i PCIe 12Gb Adapter	RAID adapter needed for SATA RAID-1 with 2x 7mm SATA drives
4Y37A78834	ThinkSystem RAID 540-8i PCIe Gen4 12Gb Adapter	RAID adapter needed for NVMe RAID-1 with 2x 7mm NVMe drives <p>Tip: Once the 540-8i adapter is installed, it will need to be configured to operate in Tri-mode to enable NVMe RAID.</p>

M.2 drives

The SR665 V3 supports one or two M.2 form-factor SATA or NVMe drives for use as an operating system boot solution or as additional storage.

The M.2 drives install into an M.2 module which is mounted horizontally in the server:

- In servers without mid-chassis drives, the M.2 module is mounted on the air baffle
- With a mid-chassis drive cage (2.5-inch or 3.5-inch), the M.2 module is mounted on the drive cage, as shown in the [Mid drive bays](#) section.

The supported M.2 modules are listed in the following table. For field upgrades see the [M.2 field upgrades](#) section below.

Table 32. M.2 modules

Part number	Feature code	Description	SATA drives	NVMe drives	RAID	Maximum supported	Windows 10/11 support
4Y37A79663	BM8X	ThinkSystem M.2 SATA/x4 NVMe 2-Bay Enablement Kit	Yes	Yes (x4 lanes)	Optional	1	Supported
4Y37A09750	B8P9	ThinkSystem M.2 NVMe 2-Bay RAID Enablement Kit	No	Yes (x1 lane)	Integrated	1	No

The ThinkSystem M.2 SATA/x4 NVMe 2-Bay Enablement Kit optionally supports RAID with the addition of a separate RAID adapter is required. For CTO orders, ordering information is listed in the following table to derive the required RAID adapter.

Table 33. CTO feature codes to select M.2 RAID (ThinkSystem M.2 SATA/x4 NVMe 2-Bay Enablement Kit only)

Feature code	Description	RAID support	Maximum supported	Windows 10/11 support
BT7N	ThinkSystem RAID 5350-8i for M.2/7mm SATA Boot Enablement	SATA	1	Supported
BT7P	ThinkSystem RAID 540-8i for M.2/7mm NVMe Boot Enablement	NVMe	1	Supported

Configuration notes:

- M.2 is not supported with all storage configurations - see [Storage configurations](#) for details.
- M.2 and 7mm are mutually exclusive: they are not supported together in the same configuration
- For field upgrades, an additional cable is needed as described in the [M.2 field upgrades](#) section below
- For ThinkSystem M.2 SATA/x4 NVMe 2-Bay Enablement Kit (4Y37A79663):
 - RAID support is implemented with the use of an additional RAID adapter installed in a slot
 - The adapter is not supported with Riser 3 or front PCIe slots
 - If RAID support is not required, the M.2 adapter connects to an onboard port. No additional adapter is required
 - The support of RAID-1 with the M.2 drives requires an additional RAID adapter that is installed in PCIe slot 2 or slot 3:
 - RAID support for M.2 SATA drives requires a RAID 5350-8i adapter (feature BT7N)
 - RAID support for M.2 NVMe drives requires a RAID 540-8i adapter operating in Tri-Mode (feature BT7P)
 - The RAID adapter used for M.2 drive support cannot be configured for use with other drive bays (not even with 7mm)
- For ThinkSystem M.2 NVMe 2-Bay RAID Enablement Kit (4Y37A09750):
 - RAID is implemented using an onboard Marvell 88NR2241 NVMe RAID controller

Supported drives are listed in the [Internal drive options](#) section.

The ThinkSystem M.2 SATA/x4 NVMe 2-Bay Enablement Kit has the following features:

- Supports one or two M.2 drives, either SATA or NVMe
- When two drives installed, they must be either both SATA or both NVMe
- Support 42mm, 60mm, 80mm and 110mm drive form factors (2242, 2260, 2280 and 22110)
- No onboard RAID; RAID functionality is provided by a separate adapter (SATA or NVMe)
- Either 6Gbps SATA or PCIe 4.0 x4 interface to the drives depending on the drives installed
- Supports monitoring and reporting of events and temperature through I2C
- Firmware update via Lenovo firmware update tools

The ThinkSystem M.2 NVMe 2-Bay RAID Enablement Kit (4Y37A09750) has the following features:

- Supports one or two NVMe M.2 drives
- Support 42mm, 60mm, 80mm and 110mm drive form factors (2242, 2260, 2280 and 22110)
- RAID support via an onboard Marvell 88NR2241 NVMe RAID Controller
- With 1 drive, supports single-drive RAID-0
- With 2 drives, supports 2-drive RAID-0, 2-drive RAID-1, or two single-drive RAID-0 arrays
- PCIe 3.0 x2 host interface; PCIe 3.0 x1 connection to each drive
- Management and configuration support via UEFI and OS-based tools
- Supports monitoring and reporting of events and temperature through I2C
- Firmware update via Lenovo firmware update tools

M.2 field upgrades

For field upgrades, the SR665 V3 also requires additional cables necessary to connect the M.2 to either the system board or RAID adapter. Ordering information is listed in the following table.

Table 34. Cable kit for M.2 drive support

Part number	Description
M.2 Cable Kit - cables for use with RAID adapters or with onboard connectivity	
4X97A87126	ThinkSystem SR665 V3 M.2 Enablement Cable Option Kit
RAID adapters for M.2 RAID support (ThinkSystem M.2 SATA/x4 NVMe 2-Bay Enablement Kit only)	
4Y37A72482	ThinkSystem RAID 5350-8i PCIe 12Gb Adapter (SATA M.2 support)
4Y37A78834	ThinkSystem RAID 540-8i PCIe Gen4 12Gb Adapter (NVMe M.2 support using Tri-Mode)

SED encryption key management with ISKLM

The server supports self-encrypting drives (SEDs) as listed in the [Internal drive options](#) section. To effectively manage a large deployment of these drives in Lenovo servers, IBM Security Key Lifecycle Manager (SKLM) offers a centralized key management solution. A Lenovo Feature on Demand (FoD) upgrade is used to enable this SKLM support in the management processor of the server.

The following table lists the part numbers and feature codes for the upgrades.

Table 35. FoD upgrades for SKLM support

Part number	Feature code	Description
Security Key Lifecycle Manager - FoD (United States, Canada, Asia Pacific, and Japan)		
00D9998	A5U1	SKLM for System x/ThinkSystem w/SEDs - FoD per Install with 1 year S&S
00D9999	AS6C	SKLM for System x/ThinkSystem w/SEDs - FoD per Install with 3 year S&S
Security Key Lifecycle Manager - FoD (Latin America, Europe, Middle East, and Africa)		
00FP648	A5U1	SKLM for System x/ThinkSystem w/SEDs - FoD per Install with 1 year S&S
00FP649	AS6C	SKLM for System x/ThinkSystem w/SEDs - FoD per Install with 3 year S&S

The IBM Security Key Lifecycle Manager software is available from Lenovo using the ordering information listed in the following table.

Table 36. IBM Security Key Lifecycle Manager licenses

Part number	Description
7S0A007FWW	IBM Security Key Lifecycle Manager Basic Edition Install License + SW Subscription & Support 12 Months
7S0A007HWW	IBM Security Key Lifecycle Manager For Raw Decimal Terabyte Storage Resource Value Unit License + SW Subscription & Support 12 Months
7S0A007KWW	IBM Security Key Lifecycle Manager For Raw Decimal Petabyte Storage Resource Value Unit License + SW Subscription & Support 12 Months
7S0A007MWW	IBM Security Key Lifecycle Manager For Usable Decimal Terabyte Storage Resource Value Unit License + SW Subscription & Support 12 Months
7S0A007PWW	IBM Security Key Lifecycle Manager For Usable Decimal Petabyte Storage Resource Value Unit License + SW Subscription & Support 12 Months

Controllers for internal storage

The SR665 V3 offers a variety of controller options for internal drives:

- For 2.5-inch and 3.5-inch drives:
 - Onboard SATA ports (feature AVUX)
 - Onboard NVMe ports (feature BC4V)
 - NVMe switch and retimer adapters (PCIe slot-based)
 - RAID adapters and HBAs for SAS/SATA drives (PCIe slot-based)
 - RAID adapters, SAS Expander, and HBAs for SAS/SATA drives (cabled in a dedicated space)
- For 7mm drive bays in the rear of the server (see the [7mm drives](#) section)
 - SATA controller integrated into the 7mm drive bay enclosure
 - NVMe controller integrated into the 7mm drive bay enclosure
- For M.2 drives internal to the server (see [M.2 drives](#) section)
 - SATA controller integrated on the M.2 SATA 2-Bay RAID Enablement Kit
 - NVMe controller integrated on the M.2 NVMe 2-Bay RAID Enablement Kit

As well as supporting RAID adapters and HBAs that install in a PCIe slot, the SR665 V3 with 2.5-inch front drive bays supports a custom form factor (CFF) adapter that is mounted in the server and cabled to one of the onboard NVMe ports. These Internal Adapters are not supported with 3.5-inch front drives due to a lack of physical space.

The following table lists the adapters used for the internal storage of the server.

Table 37. Internal Storage adapter support

Part number	Feature code	Description	Power module (supercap)	PCIe lanes	Max qty	Slots supported	Windows 10/11 support
Onboard controllers							
CTO only	AVUX	Onboard SATA AHCI Mode	No		1	N/A	Supported
CTO only	BC4V	Non RAID NVMe (Onboard NVMe)	No		1	N/A	Supported
RAID controllers - PCIe Gen 3							
4Y37A72482	BJHK	ThinkSystem RAID 5350-8i PCIe 12Gb Adapter	No	Gen3 x8	3	1,2,3,4,5,6	Supported
4Y37A72483	BJHL	ThinkSystem RAID 9350-8i 2GB Flash PCIe 12Gb Adapter	Included	Gen3 x8	3	1,2,3,4,5,6	Supported
4Y37A72484	BJHM	ThinkSystem RAID 9350-8i 2GB Flash PCIe 12Gb Internal Adapter	Included	Gen3 x8	1	Internal†	Supported
4Y37A72485	BJHN	ThinkSystem RAID 9350-16i 4GB Flash PCIe 12Gb Adapter	Included	Gen3 x8	2	1,2,3,4,5,6	Supported
4Y37A72486	BJHP	ThinkSystem RAID 9350-16i 4GB Flash PCIe 12Gb Internal Adapter	Included	Gen3 x8	1	Internal†	Supported
RAID controllers - PCIe Gen 4							
4Y37A78834	BMFT	ThinkSystem RAID 540-8i PCIe Gen4 12Gb Adapter	No	Gen4 x8	3	1,2,3,4,5,6	Supported
4Y37A78835	BNAX	ThinkSystem RAID 540-16i PCIe Gen4 12Gb Adapter	No	Gen4 x8	2	1,2,3,4,5,6	Supported
4Y37A09728†	B8NY	ThinkSystem RAID 940-8i 4GB Flash PCIe Gen4 12Gb Adapter	Included	Gen4 x8	3	1,2,3,4,5,6	Supported
4Y37A78600†	BM35	ThinkSystem RAID 940-16i 4GB Flash PCIe Gen4 12Gb Adapter	Included	Gen4 x8	2	1,2,3,4,5,6	Supported

Part number	Feature code	Description	Power module (supercap)	PCIe lanes	Max qty	Slots supported	Windows 10/11 support
4Y37A09730†	B8NZ	ThinkSystem RAID 940-16i 8GB Flash PCIe Gen4 12Gb Adapter	Included	Gen4 x8	2	1,2,3,4,5,6	Supported
4Y37A09735	B8P0	ThinkSystem RAID 940-16i 8GB Flash PCIe Gen4 12Gb Internal Adapter	Included	Gen4 x8	1	Internal‡	Supported
4Y37A09733	B8P8	ThinkSystem RAID 940-32i 8GB Flash PCIe Gen4 12Gb Adapter	Included	Gen4 x8	1	1,2,3,4,5,6	Supported
SAS HBA - PCIe Gen 3							
4Y37A72480	BJHH	ThinkSystem 4350-8i SAS/SATA 12Gb HBA	No	Gen3 x8	3	1,2,3,4,5,6	No
4Y37A72481	BJHJ	ThinkSystem 4350-16i SAS/SATA 12Gb HBA	No	Gen3 x8	2	1,2,3,4,5,6	No
SAS HBA - PCIe Gen 4							
4Y37A78601	BM51	ThinkSystem 440-8i SAS/SATA PCIe Gen4 12Gb HBA	No	Gen4 x8	3	1,2,3,4,5,6	No
4Y37A78602	BM50	ThinkSystem 440-16i SAS/SATA PCIe Gen4 12Gb HBA	No	Gen4 x8	2	1,2,3,4,5,6	No
4Y37A09725	B8P1	ThinkSystem 440-16i SAS/SATA PCIe Gen4 12Gb Internal HBA	No	Gen4 x8	1	Internal‡	No
SAS expanders							
4Y37A09736	B8P6	ThinkSystem 48 port 12Gb Internal Expander	No	Gen3 x8	1	Internal‡	Supported
NVMe adapters - PCIe Gen 4							
4C57A65446	B98C	ThinkSystem 4-Port PCIe Gen4 NVMe Retimer Adapter	No	Gen4 x16	3	1,2,3,4,5	Supported
4Y37A09728†	BGM1	ThinkSystem RAID 940-8i 4GB Flash PCIe Gen4 12Gb Adapter for U.3	Included	Gen4 x8	3	1,2,3,4,5,6	Supported
4Y37A78600†	BM36	ThinkSystem RAID 940-16i 4GB Flash PCIe Gen4 12Gb Adapter for U.3	Included	Gen4 x8	1	1,2,3,4,5,6	Supported
4Y37A09730†	BDY4	ThinkSystem RAID 940-16i 8GB Flash PCIe Gen4 12Gb Adapter for U.3	Included	Gen4 x8	1	1,2,3,4,5,6	Supported

‡ These custom form factor (CFF) adapters are only supported with 2.5-inch front drive bays. Not supported in configurations with 3.5-inch front drive bays.

† Adapter also supports PCIe 4.0 x1 connectivity to NVMe drives (requires NVMe drives with U.3 interface)

Configuration notes:

- **Supercap support limits the number of RAID adapters installable** : The table lists whether the adapter includes a power module (supercap) to power the flash memory. The server supports between 1 and 4 supercaps depending on the server configuration as described in the [RAID flash power module \(supercap\) support](#) section. The number of supercaps supported also determines the maximum number of RAID adapters with flash that can be installed in the server.
- **Field upgrades**: If you are adding a RAID adapter with supercap to the server as a field upgrade, you may need a supercap holder as described in the [RAID flash power module \(supercap\) support](#) section.

- **7mm drive support:** The storage adapters listed in the table below do *not* provide connectivity to the 7mm drive bays. The 7mm drives have their own independent RAID controller. See the [7mm drives](#) section for details.
- **E810 Ethernet and X350 RAID/HBAs:** The use of both an Intel E810 network adapter and an X350 HBA/RAID adapter (9350, 5350 and 4350) is currently not supported in ThinkSystem servers. For details see [Support Tip HT513226](#). Planned support for this combination of adapters is 4Q/2023 (SI 23-2).

The RAID 940-8i and RAID 940-16i adapters also support NVMe through a feature named Tri-Mode support (or Trimode support). This feature enables the use of NVMe U.3 drives at the same time as SAS and SATA drives. Tri-Mode requires an AnyBay backplane. Cabling of the controller to the backplanes is the same as with SAS/SATA drives, and the NVMe drives are connected via a PCIe x1 link to the controller.

NVMe drives connected using Tri-Mode support provide better performance than SAS or SATA drives: A SATA SSD has a data rate of 6Gbps, a SAS SSD has a data rate of 12Gbps, whereas an NVMe U.3 Gen 4 SSD with a PCIe x1 link will have a data rate of 16Gbps. NVMe drives typically also have lower latency and higher IOPS compared to SAS and SATA drives. Tri-Mode is supported with U.3 NVMe drives in either 2.5-inch and 3.5-inch form factor and requires an AnyBay backplane.

Tri-Mode requires U.3 drives: Only NVMe drives with a U.3 interface are supported. U.2 drives are not supported. See the [Internal drive options](#) section for the U.3 drives supported by the server.

The onboard SATA controller has the following features:

- Controller integrated into the AMD processor
- JBOD only; no RAID support
- Supports up to 20 SATA drives in the SR665 V3 (16 with one processor)
- Supports HDDs and SSDs; can be mixed

The onboard NVMe support has the following features:

- Controller integrated into the AMD processor
- Supports up to 20x NVMe drives direct connected to onboard ports; additional drives through retimer/switch adapters
- Each drive has PCIe 5.0 x4 host interface
- Supports JBOD - Intel and non-Intel NVMe SSDs
- No support for RAID

For specifications about the RAID adapters and HBAs supported by the SR665 V3, see the ThinkSystem RAID Adapter and HBA Reference, available from:

<https://lenovopress.lenovo.com/lp1288-thinksystem-raid-adapter-and-hba-reference#sr665-v3-support=SR665%2520V3>

For more information about each of the adapters, see the product guides in the RAID adapters or HBA sections of the Lenovo Press web site:

<https://lenovopress.com/servers/options/raid>
<https://lenovopress.com/servers/options/hba>

Internal drive options

The following tables list the drive options for internal storage of the server.

2.5-inch hot-swap drives:

- [2.5-inch hot-swap 12 Gb SAS HDDs](#)
- [2.5-inch hot-swap 24 Gb SAS SSDs](#)
- [2.5-inch hot-swap 12 Gb SAS SSDs](#)
- [2.5-inch hot-swap 6 Gb SATA SSDs](#)
- [2.5-inch hot-swap PCIe 5.0 NVMe SSDs](#)
- [2.5-inch hot-swap PCIe 4.0 NVMe SSDs](#)

2.5-inch 7mm hot-swap drives:

- [7mm 2.5-inch hot-swap 6 Gb SATA SSDs](#)
- [7mm 2.5-inch hot-swap PCIe 4.0 NVMe SSDs](#)

3.5-inch hot-swap drives:

- [3.5-inch hot-swap 12 Gb SAS HDDs](#)
- [3.5-inch hot-swap 6 Gb SATA HDDs](#)
- [3.5-inch hot-swap 24 Gb SAS SSDs](#)
- [3.5-inch hot-swap 12 Gb SAS SSDs](#)
- [3.5-inch hot-swap 6 Gb SATA SSDs](#)
- [3.5-inch hot-swap PCIe 4.0 NVMe SSDs](#)

M.2 drives:

- [M.2 SATA drives](#)
- [M.2 PCIe 4.0 NVMe drives](#)

M.2 drive support: The use of M.2 drives requires an additional adapter as described in the [M.2 drives](#) subsection.

SED support: The tables include a column to indicate which drives support SED encryption. The encryption functionality can be disabled if needed. Note: Not all SED-enabled drives have "SED" in the description.

Table 38. 2.5-inch hot-swap 12 Gb SAS HDDs

Part number	Feature code	Description	SED support	Max Qty
2.5-inch hot-swap HDDs - 12 Gb SAS 15K				
7XB7A00021	AULV	ThinkSystem 2.5" 300GB 15K SAS 12Gb Hot Swap 512n HDD	No	40
7XB7A00022	AULW	ThinkSystem 2.5" 600GB 15K SAS 12Gb Hot Swap 512n HDD	No	40
7XB7A00023	AULX	ThinkSystem 2.5" 900GB 15K SAS 12Gb Hot Swap 512e HDD	No	40
2.5-inch hot-swap HDDs - 12 Gb SAS 10K				
7XB7A00025	AULZ	ThinkSystem 2.5" 600GB 10K SAS 12Gb Hot Swap 512n HDD	No	40
7XB7A00027	AUM1	ThinkSystem 2.5" 1.2TB 10K SAS 12Gb Hot Swap 512n HDD	No	40
7XB7A00028	AUM2	ThinkSystem 2.5" 1.8TB 10K SAS 12Gb Hot Swap 512e HDD	No	40
4XB7A83970	BRG7	ThinkSystem 2.5" 2.4TB 10K SAS 12Gb Hot Swap 512e HDD v2	No	40
2.5-inch hot-swap SED HDDs - 12 Gb SAS 10K				
7XB7A00031	AUM5	ThinkSystem 2.5" 600GB 10K SAS 12Gb Hot Swap 512n HDD SED	Support	40
7XB7A00033	B0YX	ThinkSystem 2.5" 1.2TB 10K SAS 12Gb Hot Swap 512n HDD SED	Support	40
4XB7A84038	BRG8	ThinkSystem 2.5" 2.4TB 10K SAS 12Gb Hot Swap 512e HDD FIPS v2	Support	40

Table 39. 2.5-inch hot-swap 24 Gb SAS SSDs

Part number	Feature code	Description	SED support	Max Qty
2.5-inch hot-swap SSDs - 24 Gb SAS - Mixed Use/Mainstream (3-5 DWPD)				
4XB7A80340	BNW8	ThinkSystem 2.5" PM1655 800GB Mixed Use SAS 24Gb HS SSD	Support	40
4XB7A80341	BNW9	ThinkSystem 2.5" PM1655 1.6TB Mixed Use SAS 24Gb HS SSD	Support	40
4XB7A80342	BNW6	ThinkSystem 2.5" PM1655 3.2TB Mixed Use SAS 24Gb HS SSD	Support	40
4XB7A80343	BP3K	ThinkSystem 2.5" PM1655 6.4TB Mixed Use SAS 24Gb HS SSD	Support	40
2.5-inch hot-swap SSDs - 24 Gb SAS - Read Intensive/Entry/Capacity (<3 DWPD)				
4XB7A80318	BNWC	ThinkSystem 2.5" PM1653 960GB Read Intensive SAS 24Gb HS SSD	Support	40
4XB7A80319	BNWE	ThinkSystem 2.5" PM1653 1.92TB Read Intensive SAS 24Gb HS SSD	Support	40
4XB7A80320	BNWF	ThinkSystem 2.5" PM1653 3.84TB Read Intensive SAS 24Gb HS SSD	Support	40
4XB7A80321	BP3E	ThinkSystem 2.5" PM1653 7.68TB Read Intensive SAS 24Gb HS SSD	Support	40
4XB7A80322	BP3J	ThinkSystem 2.5" PM1653 15.36TB Read Intensive SAS 24Gb HS SSD	Support	40
4XB7A80323	BP3D	ThinkSystem 2.5" PM1653 30.72TB Read Intensive SAS 24Gb HS SSD	Support	40

Table 40. 2.5-inch hot-swap 12 Gb SAS SSDs

Part number	Feature code	Description	SED support	Max Qty
2.5-inch hot-swap SSDs - 12 Gb SAS - Write Intensive/Performance (10+ DWPD)				
4XB7A83214	BR10	ThinkSystem 2.5" Nytro 3750 400GB Write Intensive SAS 12Gb HS SSD	Support	40
4XB7A83215	BR0Z	ThinkSystem 2.5" Nytro 3750 800GB Write Intensive SAS 12Gb HS SSD	Support	40
4XB7A83216	BR0Y	ThinkSystem 2.5" Nytro 3750 1.6TB Write Intensive SAS 12Gb HS SSD	Support	40
4XB7A83217	BR0X	ThinkSystem 2.5" Nytro 3750 3.2TB Write Intensive SAS 12Gb HS SSD	Support	40

Table 41. 2.5-inch hot-swap 6 Gb SATA SSDs

Part number	Feature code	Description	SED support	Max Qty
2.5-inch hot-swap SSDs - 6 Gb SATA - Mixed Use/Mainstream (3-5 DWPD)				
4XB7A82289	BQ21	ThinkSystem 2.5" 5400 MAX 480GB Mixed Use SATA 6Gb HS SSD	Support	40
4XB7A82290	BQ24	ThinkSystem 2.5" 5400 MAX 960GB Mixed Use SATA 6Gb HS SSD	Support	40
4XB7A82291	BQ22	ThinkSystem 2.5" 5400 MAX 1.92TB Mixed Use SATA 6Gb HS SSD	Support	40
4XB7A82292	BQ23	ThinkSystem 2.5" 5400 MAX 3.84TB Mixed Use SATA 6Gb HS SSD	Support	40
4XB7A17125	BA7Q	ThinkSystem 2.5" S4620 480GB Mixed Use SATA 6Gb HS SSD	No	40
4XB7A17126	BA4T	ThinkSystem 2.5" S4620 960GB Mixed Use SATA 6Gb HS SSD	No	40
4XB7A17127	BA4U	ThinkSystem 2.5" S4620 1.92TB Mixed Use SATA 6Gb HS SSD	No	40
4XB7A17128	BK7L	ThinkSystem 2.5" S4620 3.84TB Mixed Use SATA 6Gb HS SSD	No	40
2.5-inch hot-swap SSDs - 6 Gb SATA - Read Intensive/Entry (<3 DWPD)				
4XB7A89423	BXDY	ThinkSystem 2.5" CM893a 1.92TB Read Intensive SATA 6Gb HS SSD	Support	40
4XB7A87524	BWKN	ThinkSystem 2.5" PM893a 480GB Read Intensive SATA 6Gb HS SSD	Support	40
4XB7A87525	BWKM	ThinkSystem 2.5" PM893a 960GB Read Intensive SATA 6Gb HS SSD	Support	40
4XB7A87526	BWKL	ThinkSystem 2.5" PM893a 1.92TB Read Intensive SATA 6Gb HS SSD	Support	40
4XB7A87527	BWKK	ThinkSystem 2.5" PM893a 3.84TB Read Intensive SATA 6Gb HS SSD	Support	40
4XB7A82258	BQ1Q	ThinkSystem 2.5" 5400 PRO 240GB Read Intensive SATA 6Gb HS SSD	Support	40
4XB7A82259	BQ1P	ThinkSystem 2.5" 5400 PRO 480GB Read Intensive SATA 6Gb HS SSD	Support	40
4XB7A82260	BQ1R	ThinkSystem 2.5" 5400 PRO 960GB Read Intensive SATA 6Gb HS SSD	Support	40
4XB7A82261	BQ1X	ThinkSystem 2.5" 5400 PRO 1.92TB Read Intensive SATA 6Gb HS SSD	Support	40
4XB7A82262	BQ1S	ThinkSystem 2.5" 5400 PRO 3.84TB Read Intensive SATA 6Gb HS SSD	Support	40
4XB7A82263	BQ1T	ThinkSystem 2.5" 5400 PRO 7.68TB Read Intensive SATA 6Gb HS SSD	Support	40
4XB7A72438	BM8B	ThinkSystem 2.5" PM893 480GB Read Intensive SATA 6Gb HS SSD	No	40
4XB7A72439	BM8A	ThinkSystem 2.5" PM893 960GB Read Intensive SATA 6Gb HS SSD	No	40
4XB7A72440	BM89	ThinkSystem 2.5" PM893 1.92TB Read Intensive SATA 6Gb HS SSD	No	40
4XB7A72441	BM88	ThinkSystem 2.5" PM893 3.84TB Read Intensive SATA 6Gb HS SSD	No	40
4XB7A72442	BM87	ThinkSystem 2.5" PM893 7.68TB Read Intensive SATA 6Gb HS SSD	No	40
4XB7A17072	B99D	ThinkSystem 2.5" S4520 240GB Read Intensive SATA 6Gb HS SSD	No	40
4XB7A17101	BA7G	ThinkSystem 2.5" S4520 480GB Read Intensive SATA 6Gb HS SSD	No	40
4XB7A17102	BA7H	ThinkSystem 2.5" S4520 960GB Read Intensive SATA 6Gb HS SSD	No	40
4XB7A17103	BA7J	ThinkSystem 2.5" S4520 1.92TB Read Intensive SATA 6Gb HS SSD	No	40
4XB7A17104	BK77	ThinkSystem 2.5" S4520 3.84TB Read Intensive SATA 6Gb HS SSD	No	40
4XB7A17105	BK78	ThinkSystem 2.5" S4520 7.68TB Read Intensive SATA 6Gb HS SSD	No	40

Table 42. 2.5-inch hot-swap PCIe 5.0 NVMe SSDs

Part number	Feature code	Description	SED support	Max Qty
2.5-inch SSDs - U.2 PCIe 5.0 NVMe - Read Intensive/Entry (<3 DWPD)				
4XB7A82366	BTPZ	ThinkSystem 2.5" U.3 PM1743 1.92TB Read Intensive NVMe PCIe 5.0 x4 HS SSD	Support	32
4XB7A82367	BTQ0	ThinkSystem 2.5" U.3 PM1743 3.84TB Read Intensive NVMe PCIe 5.0 x4 HS SSD	Support	32
4XB7A82368	BTQ1	ThinkSystem 2.5" U.3 PM1743 7.68TB Read Intensive NVMe PCIe 5.0 x4 HS SSD	Support	32
4XB7A82369	BTQ2	ThinkSystem 2.5" U.3 PM1743 15.36TB Read Intensive NVMe PCIe 5.0 x4 HS SSD	Support	32

Table 43. 2.5-inch hot-swap PCIe 4.0 NVMe SSDs

Part number	Feature code	Description	SED support	Max Qty
2.5-inch SSDs - U.2 PCIe 4.0 NVMe - Write Intensive/Performance (10+ DWPD)				
4XB7A17158	BKKY	ThinkSystem 2.5" U.2 P5800X 400GB Write Intensive NVMe PCIe 4.0 x4 HS SSD	No	32
4XB7A17159	BKKZ	ThinkSystem 2.5" U.2 P5800X 800GB Write Intensive NVMe PCIe 4.0 x4 HS SSD	No	32
4XB7A17160	BMM8	ThinkSystem 2.5" U.2 P5800X 1.6TB Write Intensive NVMe PCIe 4.0 x4 HS SSD	No	32
2.5-inch SSDs - U.2 PCIe 4.0 NVMe - Mixed Use/Mainstream (3-5 DWPD)				
4XB7A17129	BNEG	ThinkSystem 2.5" U.2 P5620 1.6TB Mixed Use NVMe PCIe 4.0 x4 HS SSD	Support	32
4XB7A17130	BNEH	ThinkSystem 2.5" U.2 P5620 3.2TB Mixed Use NVMe PCIe 4.0 x4 HS SSD	Support	32
4XB7A17133	BNEZ	ThinkSystem 2.5" U.2 P5620 6.4TB Mixed Use NVMe PCIe 4.0 x4 HS SSD	Support	32
4XB7A17136	BA4V	ThinkSystem 2.5" U.2 P5620 12.8TB Mixed Use NVMe PCIe 4.0 x4 HS SSD	Support	32
2.5-inch SSDs - U.3 PCIe 4.0 NVMe - Mixed Use/Mainstream (3-5 DWPD)				
4XB7A79639	BNF1	ThinkSystem 2.5" U.3 7450 MAX 800GB Mixed Use NVMe PCIe 4.0 x4 HS SSD	Support	32
4XB7A13967	BNEJ	ThinkSystem 2.5" U.3 7450 MAX 1.6TB Mixed Use NVMe PCIe 4.0 x4 HS SSD	Support	32
4XB7A13970	BNEY	ThinkSystem 2.5" U.3 7450 MAX 3.2TB Mixed Use NVMe PCIe 4.0 x4 HS SSD	Support	32
4XB7A13971	BNEL	ThinkSystem 2.5" U.3 7450 MAX 6.4TB Mixed Use NVMe PCIe 4.0 x4 HS SSD	Support	32
4XB7A84056	BRG0	ThinkSystem 2.5" U.3 7450 MAX 12.8TB Mixed Use NVMe PCIe 4.0 x4 HS SSD	Support	32
2.5-inch SSDs - U.2 PCIe 4.0 NVMe - Read Intensive/Entry (<3 DWPD)				
4XB7A90099	BXMB	ThinkSystem 2.5" U.2 PM9A3 960GB Read Intensive NVMe PCIe 4.0 x4 HS SSD	Support	32

Part number	Feature code	Description	SED support	Max Qty
4XB7A90100	BXMA	ThinkSystem 2.5" U.2 PM9A3 1.92TB Read Intensive NVMe PCIe 4.0 x4 HS SSD	Support	32
4XB7A90101	BXM9	ThinkSystem 2.5" U.2 PM9A3 3.84TB Read Intensive NVMe PCIe 4.0 x4 HS SSD	Support	32
4XB7A13941	BMGD	ThinkSystem 2.5" U.2 P5520 1.92TB Read Intensive NVMe PCIe 4.0 x4 HS SSD	Support	32
4XB7A13942	BMGE	ThinkSystem 2.5" U.2 P5520 3.84TB Read Intensive NVMe PCIe 4.0 x4 HS SSD	Support	32
4XB7A13943	BNEF	ThinkSystem 2.5" U.2 P5520 7.68TB Read Intensive NVMe PCIe 4.0 x4 HS SSD	Support	32
4XB7A13631	BNEQ	ThinkSystem 2.5" U.2 P5520 15.36TB Read Intensive NVMe PCIe 4.0 x4 HS SSD	Support	32
2.5-inch SSDs - U.3 PCIe 4.0 NVMe - Read Intensive/Entry (<3 DWPD)				
4XB7A79646	BNF3	ThinkSystem 2.5" U.3 7450 PRO 960GB Read Intensive NVMe PCIe 4.0 x4 HS SSD	Support	32
4XB7A79647	BNF2	ThinkSystem 2.5" U.3 7450 PRO 1.92TB Read Intensive NVMe PCIe 4.0 x4 HS SSD	Support	32
4XB7A79648	BNF5	ThinkSystem 2.5" U.3 7450 PRO 3.84TB Read Intensive NVMe PCIe 4.0 x4 HS SSD	Support	32
4XB7A79649	BNF4	ThinkSystem 2.5" U.3 7450 PRO 7.68TB Read Intensive NVMe PCIe 4.0 x4 HS SSD	Support	32
4XB7A83097	BQAV	ThinkSystem 2.5" U.3 7450 PRO 15.36TB Read Intensive NVMe PCIe 4.0 x4 HS SSD	Support	32

Table 44. 7mm 2.5-inch hot-swap 6 Gb SATA SSDs

Part number	Feature code	Description	SED support	Max Qty
7mm 2.5-inch hot-swap SSDs - 6 Gb SATA - Read Intensive/Entry (<3 DWPD)				
4XB7A82264	BQ1U	ThinkSystem 7mm 5400 PRO 240GB Read Intensive SATA 6Gb HS SSD	Support	2
4XB7A82265	BQ1V	ThinkSystem 7mm 5400 PRO 480GB Read Intensive SATA 6Gb HS SSD	Support	2
4XB7A82266	BQ1W	ThinkSystem 7mm 5400 PRO 960GB Read Intensive SATA 6Gb HS SSD	Support	2
4XB7A17106	BK79	ThinkSystem 7mm S4520 240GB Read Intensive SATA 6Gb HS SSD	No	2
4XB7A17107	BK7A	ThinkSystem 7mm S4520 480GB Read Intensive SATA 6Gb HS SSD	No	2
4XB7A17108	BK7B	ThinkSystem 7mm S4520 960GB Read Intensive SATA 6Gb HS SSD	No	2

Table 45. 7mm 2.5-inch hot-swap PCIe 4.0 NVMe SSDs

Part number	Feature code	Description	SED support	Max Qty
7mm 2.5-inch hot-swap SSDs - PCIe 4.0 NVMe - Read Intensive/Entry (<3 DWPD)				
4XB7A90096	BXMN	ThinkSystem 7mm U.2 PM9A3 960GB Read Intensive NVMe PCIe 4.0 x4 HS SSD	Support	2
4XB7A90097	BXMM	ThinkSystem 7mm U.2 PM9A3 1.92TB Read Intensive NVMe PCIe 4.0 x4 HS SSD	Support	2
4XB7A90098	BXML	ThinkSystem 7mm U.2 PM9A3 3.84TB Read Intensive NVMe PCIe 4.0 x4 HS SSD	Support	2
4XB7A82853	BPZ4	ThinkSystem 7mm U.3 7450 PRO 960GB Read Intensive NVMe PCIe 4.0 x4 HS SSD	Support	2
4XB7A82855	BPZ5	ThinkSystem 7mm U.3 7450 PRO 1.92TB Read Intensive NVMe PCIe 4.0 x4 HS SSD	Support	2
4XB7A82856	BPZ6	ThinkSystem 7mm U.3 7450 PRO 3.84TB Read Intensive NVMe PCIe 4.0 x4 HS SSD	Support	2

Table 46. 3.5-inch hot-swap 12 Gb SAS HDDs

Part number	Feature code	Description	SED support	Max Qty
3.5-inch hot-swap HDDs - 12 Gb NL SAS				
7XB7A00042	AUU5	ThinkSystem 3.5" 2TB 7.2K SAS 12Gb Hot Swap 512n HDD	No	20
7XB7A00043	AUU6	ThinkSystem 3.5" 4TB 7.2K SAS 12Gb Hot Swap 512n HDD	No	20
7XB7A00044	AUU7	ThinkSystem 3.5" 6TB 7.2K SAS 12Gb Hot Swap 512e HDD	No	20
7XB7A00045	B0YR	ThinkSystem 3.5" 8TB 7.2K SAS 12Gb Hot Swap 512e HDD	No	20
7XB7A00046	AUUG	ThinkSystem 3.5" 10TB 7.2K SAS 12Gb Hot Swap 512e HDD	No	20
7XB7A00067	B117	ThinkSystem 3.5" 12TB 7.2K SAS 12Gb Hot Swap 512e HDD	No	20
4XB7A13906	B496	ThinkSystem 3.5" 14TB 7.2K SAS 12Gb Hot Swap 512e HDD	No	20
4XB7A13911	B7EZ	ThinkSystem 3.5" 16TB 7.2K SAS 12Gb Hot Swap 512e HDD	No	20
4XB7A38266	BCFP	ThinkSystem 3.5" 18TB 7.2K SAS 12Gb Hot Swap 512e HDD	No	20
4XB7A80353	BPKU	ThinkSystem 3.5" 20TB 7.2K SAS 12Gb Hot Swap 512e HDD	No	20
4XB7A83766	BTR7	ThinkSystem 3.5" 22TB 7.2K SAS 12Gb Hot Swap 512e HDD	Support	20
3.5-inch hot-swap SED HDDs - 12 Gb NL SAS				
7XB7A00066	B0YQ	ThinkSystem 3.5" 8TB 7.2K SAS 12Gb Hot Swap 512e HDD FIPS	Support	20

Table 47. 3.5-inch hot-swap 6 Gb SATA HDDs

Part number	Feature code	Description	SED support	Max Qty
3.5-inch hot-swap HDDs - 6 Gb NL SATA				
7XB7A00049	AUUF	ThinkSystem 3.5" 1TB 7.2K SATA 6Gb Hot Swap 512n HDD	No	20
7XB7A00050	AUUD	ThinkSystem 3.5" 2TB 7.2K SATA 6Gb Hot Swap 512n HDD	No	20
7XB7A00051	AUU8	ThinkSystem 3.5" 4TB 7.2K SATA 6Gb Hot Swap 512n HDD	No	20
7XB7A00052	AUUA	ThinkSystem 3.5" 6TB 7.2K SATA 6Gb Hot Swap 512e HDD	No	20
7XB7A00053	AUU9	ThinkSystem 3.5" 8TB 7.2K SATA 6Gb Hot Swap 512e HDD	No	20
7XB7A00054	AUUB	ThinkSystem 3.5" 10TB 7.2K SATA 6Gb Hot Swap 512e HDD	No	20
7XB7A00068	B118	ThinkSystem 3.5" 12TB 7.2K SATA 6Gb Hot Swap 512e HDD	No	20
4XB7A13907	B497	ThinkSystem 3.5" 14TB 7.2K SATA 6Gb Hot Swap 512e HDD	No	20
4XB7A13914	B7F0	ThinkSystem 3.5" 16TB 7.2K SATA 6Gb Hot Swap 512e HDD	No	20
4XB7A38130	BCFH	ThinkSystem 3.5" 18TB 7.2K SATA 6Gb Hot Swap 512e HDD	No	20
4XB7A80354	BPKV	ThinkSystem 3.5" 20TB 7.2K SATA 6Gb Hot Swap 512e HDD	No	20
4XB7A83765	BTR8	ThinkSystem 3.5" 22TB 7.2K SATA 6Gb Hot Swap 512e HDD	Support	20

Table 48. 3.5-inch hot-swap 24 Gb SAS SSDs

Part number	Feature code	Description	SED support	Max Qty
3.5-inch hot-swap SSDs - 24 Gb SAS - Mixed Use/Mainstream (3-5 DWPD)				
4XB7A80344	BNW7	ThinkSystem 3.5" PM1655 800GB Mixed Use SAS 24Gb HS SSD	Support	20
4XB7A80345	BNWA	ThinkSystem 3.5" PM1655 1.6TB Mixed Use SAS 24Gb HS SSD	Support	20
4XB7A80346	BNWB	ThinkSystem 3.5" PM1655 3.2TB Mixed Use SAS 24Gb HS SSD	Support	20
4XB7A80347	BP3G	ThinkSystem 3.5" PM1655 6.4TB Mixed Use SAS 24Gb HS SSD	Support	20
3.5-inch hot-swap SSDs - 24 Gb SAS - Read Intensive/Entry/Capacity (<3 DWPD)				
4XB7A80324	BNWD	ThinkSystem 3.5" PM1653 960GB Read Intensive SAS 24Gb HS SSD	Support	20
4XB7A80325	BNWG	ThinkSystem 3.5" PM1653 1.92TB Read Intensive SAS 24Gb HS SSD	Support	20
4XB7A80326	BNWH	ThinkSystem 3.5" PM1653 3.84TB Read Intensive SAS 24Gb HS SSD	Support	20
4XB7A80327	BP3F	ThinkSystem 3.5" PM1653 7.68TB Read Intensive SAS 24Gb HS SSD	Support	20
4XB7A80328	BP3H	ThinkSystem 3.5" PM1653 15.36TB Read Intensive SAS 24Gb HS SSD	Support	20

Table 49. 3.5-inch hot-swap 12 Gb SAS SSDs

Part number	Feature code	Description	SED support	Max Qty
3.5-inch hot-swap SSDs - 12 Gb SAS - Write Intensive/Performance (10+ DWPD)				
4XB7A83218	BR0W	ThinkSystem 3.5" Nytro 3750 400GB Write Intensive SAS 12Gb HS SSD	Support	20
4XB7A83219	BR0V	ThinkSystem 3.5" Nytro 3750 800GB Write Intensive SAS 12Gb HS SSD	Support	20
4XB7A83220	BR0U	ThinkSystem 3.5" Nytro 3750 1.6TB Write Intensive SAS 12Gb HS SSD	Support	20
4XB7A83221	BR0T	ThinkSystem 3.5" Nytro 3750 3.2TB Write Intensive SAS 12Gb HS SSD	Support	20

Table 50. 3.5-inch hot-swap 6 Gb SATA SSDs

Part number	Feature code	Description	SED support	Max Qty
3.5-inch hot-swap SSDs - 6 Gb SATA - Mixed Use/Mainstream (3-5 DWPD)				
4XB7A17137	BA4W	ThinkSystem 3.5" S4620 480GB Mixed Use SATA 6Gb HS SSD	No	20
4XB7A17138	BA4X	ThinkSystem 3.5" S4620 960GB Mixed Use SATA 6Gb HS SSD	No	20
4XB7A17139	BA4Y	ThinkSystem 3.5" S4620 1.92TB Mixed Use SATA 6Gb HS SSD	No	20
4XB7A17140	BK7P	ThinkSystem 3.5" S4620 3.84TB Mixed Use SATA 6Gb HS SSD	No	20
3.5-inch hot-swap SSDs - 6 Gb SATA - Read Intensive/Entry (<3 DWPD)				
4XB7A17118	BA7K	ThinkSystem 3.5" S4520 240GB Read Intensive SATA 6Gb HS SSD	No	20
4XB7A17119	BA7L	ThinkSystem 3.5" S4520 480GB Read Intensive SATA 6Gb HS SSD	No	20
4XB7A17120	BA7M	ThinkSystem 3.5" S4520 960GB Read Intensive SATA 6Gb HS SSD	No	20
4XB7A17121	BA7N	ThinkSystem 3.5" S4520 1.92TB Read Intensive SATA 6Gb HS SSD	No	20
4XB7A17122	BK7F	ThinkSystem 3.5" S4520 3.84TB Read Intensive SATA 6Gb HS SSD	No	20
4XB7A17123	BK7G	ThinkSystem 3.5" S4520 7.68TB Read Intensive SATA 6Gb HS SSD	No	20

Table 51. 3.5-inch hot-swap PCIe 4.0 NVMe SSDs

Part number	Feature code	Description	SED support	Max Qty
3.5-inch SSDs - U.2 PCIe 4.0 NVMe - Write Intensive/Performance (10+ DWPD)				
4XB7A17161	BMM7	ThinkSystem 3.5" U.2 P5800X 400GB Write Intensive NVMe PCIe 4.0 x4 HS SSD	No	12
4XB7A17162	BMM5	ThinkSystem 3.5" U.2 P5800X 800GB Write Intensive NVMe PCIe 4.0 x4 HS SSD	No	12
4XB7A77070	BMM6	ThinkSystem 3.5" U.2 P5800X 1.6TB Write Intensive NVMe PCIe 4.0 x4 HS SSD	No	12
3.5-inch SSDs - U.2 PCIe 4.0 NVMe - Mixed Use/Mainstream (3-5 DWPD)				
4XB7A17141	BNEK	ThinkSystem 3.5" U.2 P5620 1.6TB Mixed Use NVMe PCIe 4.0 x4 HS SSD	Support	12
4XB7A17143	BNEM	ThinkSystem 3.5" U.2 P5620 3.2TB Mixed Use NVMe PCIe 4.0 x4 HS SSD	Support	12
4XB7A17144	BNEN	ThinkSystem 3.5" U.2 P5620 6.4TB Mixed Use NVMe PCIe 4.0 x4 HS SSD	Support	12
4XB7A17148	BNEP	ThinkSystem 3.5" U.2 P5620 12.8TB Mixed Use NVMe PCIe 4.0 x4 HS SSD	Support	12
3.5-inch SSDs - U.2 PCIe 4.0 NVMe - Read Intensive/Entry (<3 DWPD)				
4XB7A13632	BNES	ThinkSystem 3.5" U.2 P5520 1.92TB Read Intensive NVMe PCIe 4.0 x4 HS SSD	Support	12
4XB7A76777	BNET	ThinkSystem 3.5" U.2 P5520 3.84TB Read Intensive NVMe PCIe 4.0 x4 HS SSD	Support	12
4XB7A76778	BNEU	ThinkSystem 3.5" U.2 P5520 7.68TB Read Intensive NVMe PCIe 4.0 x4 HS SSD	Support	12
4XB7A76779	BNF0	ThinkSystem 3.5" U.2 P5520 15.36TB Read Intensive NVMe PCIe 4.0 x4 HS SSD	Support	12

Table 52. M.2 SATA drives

Part number	Feature code	Description	SED support	Max Qty
M.2 SSDs - 6 Gb SATA - Read Intensive/Entry (<3 DWPD)				
4XB7A82286	BQ1Z	ThinkSystem M.2 5400 PRO 240GB Read Intensive SATA 6Gb NHS SSD	Support	2
4XB7A82287	BQ1Y	ThinkSystem M.2 5400 PRO 480GB Read Intensive SATA 6Gb NHS SSD	Support	2
4XB7A82288	BQ20	ThinkSystem M.2 5400 PRO 960GB Read Intensive SATA 6Gb NHS SSD	Support	2
7N47A00130	AUUV	ThinkSystem M.2 128GB SATA 6Gbps Non-Hot Swap SSD	No	2

Table 53. M.2 PCIe 4.0 NVMe drives

Part number	Feature code	Description	SED support	Max Qty
M.2 SSDs - PCIe 4.0 NVMe - Read Intensive/Entry (<3 DWPD)				
4XB7A13999	BKSR	ThinkSystem M.2 7450 PRO 960GB Read Intensive NVMe PCIe 4.0 x4 NHS SSD	Support	2

USB memory key

For general portable storage needs, the server also supports the USB memory key option that is listed in the following table.

Table 54. USB memory key

Part number	Feature	Description
4X77A77065	BNWN	ThinkSystem USB 32GB USB 3.0 Flash Drive

Internal backup units

The server does not supports any internal backup units, such as tape drives or RDX drives. External backup units are available as described in the [External backup units](#) section.

Optical drives

The server supports the external USB optical drive listed in the following table.

Table 55. External optical drive

Part number	Feature code	Description
7XA7A05926	AVV8	ThinkSystem External USB DVD RW Optical Disk Drive

The drive is based on the Lenovo Slim DVD Burner DB65 drive and supports the following formats: DVD-RAM, DVD-RW, DVD+RW, DVD+R, DVD-R, DVD-ROM, DVD-R DL, CD-RW, CD-R, CD-ROM.

I/O expansion

The SR665 V3 supports a total of up to 12x PCIe slots, 10x at the rear and 2x at the front, plus 1x OCP 3.0 SFF slot for networking. The OCP slot can be either at the front or at the rear (but not both). Slot availability is based on riser selection and drive bays configured. The use of some slots requires that both processors be installed as listed below.

Topics in this section:

- [Slot layout and connections](#)
- [Slot combinations](#)
- [Slot ordering information](#)
- [Serial port](#)

Slot layout and connections

The slots are provided by riser cards:

- Riser 1: Slots 1, 2 and 3, all full-height slots (connect to CPU 1)
- Riser 2: Slots 4, 5, and 6, all full-height slots (connect to CPU 2)
- Riser 3: Slot 7 and 8
 - When configured as full-height slots: Slot 7 connects to CPU 1, slot 8 to CPU 2
 - When configured as low-profile slots: Both slots connect to CPU 1
- Riser 4: Slots 9 and 10 (connect to CPU 2)

NVMe support: The use of Riser 3 is mutually exclusive to onboard NVMe support as they use the same PCIe connectors.

The slots in each riser are either PCIe x16 or PCIe x8 depending on the riser card selected as listed in the table below. All x8 slots are open-ended and physically support x16 adapters. Depending on the risers selected, slots are either PCIe 5.0 or PCIe 4.0.

The SR665 V3 also supports front-accessible PCIe slots: 2x PCIe 4.0 x16 slots plus a dedicated OCP 3.0 SFF slot for networking. Front-accessible slots are as follows:

- Slot 11: PCIe 4.0 x16 FHHL (connects to CPU 2)
- Slot 12: PCIe 4.0 x16 FHHL (connects to CPU 2)

As discussed in the [Internal storage](#) section, the server supports drive bays in the rear of the server. Depending on the drive bays selected, the number of slots available for adapters is reduced. The figure below shows the supported combinations of slots and drive bays.

Internal HBA/RAID adapter: For configurations with 2.5-inch front drive bays, an internal RAID adapter or HBA can be installed in a dedicated space and cabled to a PCIe x8 connector, thereby freeing up a slot for other purposes.

The following figure shows the locations of the rear-accessible slots for each configuration selection. The OCP slot is located in the lower-left corner.

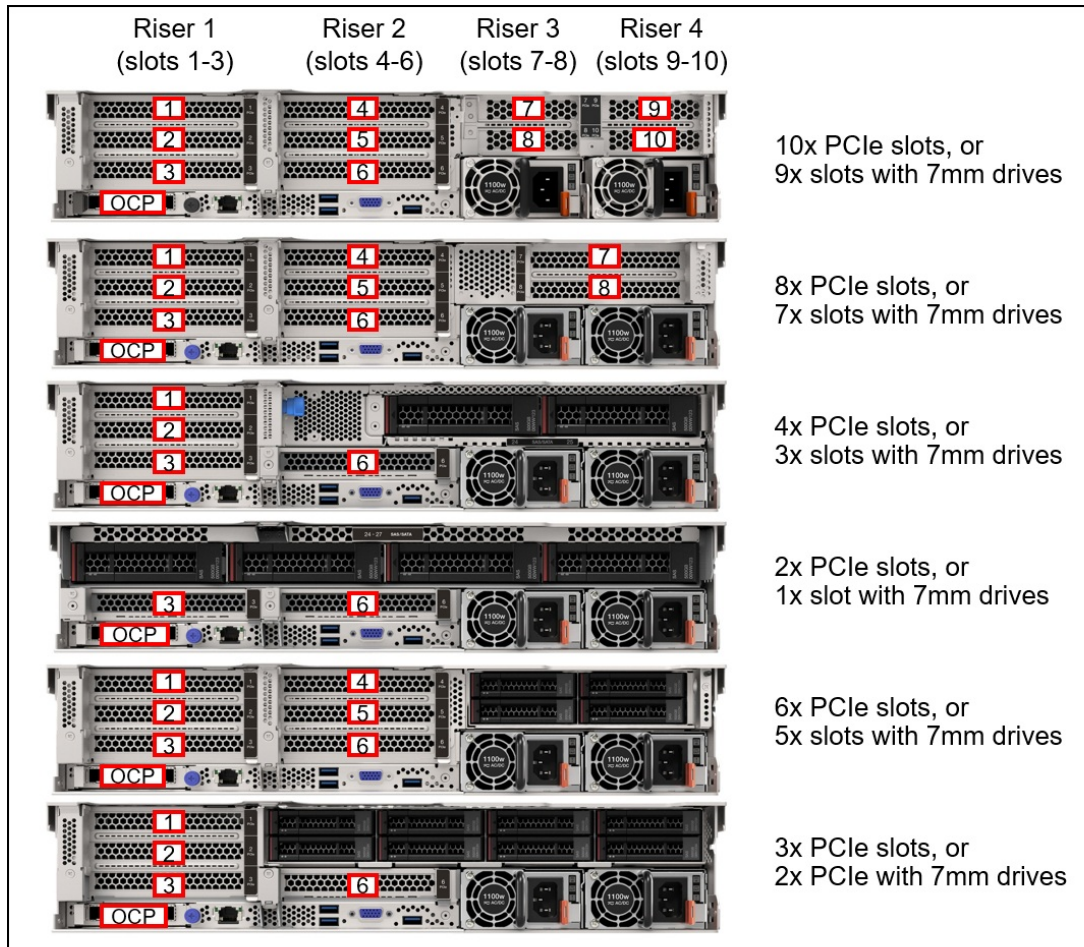

Figure 14. SR665 V3 rear slot configurations

The following figure shows the locations of the front-accessible slots.

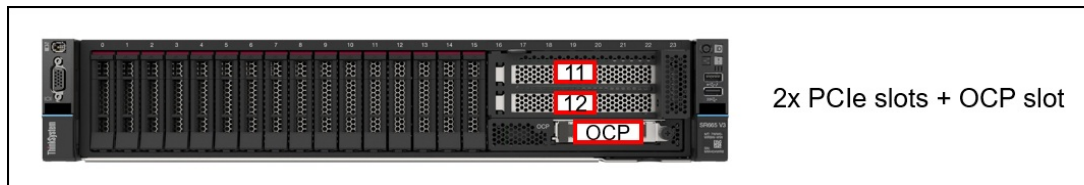

Figure 15. SR665 V3 front slots

Slot combinations

The SR665 V3 supports the riser combinations as listed in the following table. The table lists the PCIe slot risers in the rear of the server, the PCIe slots in the front of the server, and the front & rear OCP slots.

The table also lists the total number of PCIe slots (excluding the OCP slot) assuming a 3-slot riser is selected for Riser 1 and Riser 2.

Table 56. Slot combinations

Total PCIe slots	Riser 1	Riser 2	Riser 3	Riser 4	Front slots	Rear OCP	Front OCP
Rear slots + Rear OCP							
3	Yes	No	No	No	No	Yes	No
6	Yes	Yes	No	No	No	Yes	No
8	Yes	Yes	Yes	No	No	Yes	No
10	Yes	Yes	Yes	Yes	No	Yes	No
Rear + Front slots + Rear OCP							
5	Yes	No	No	No	Yes	Yes	No
8	Yes	Yes	No	No	Yes	Yes	No
10	Yes	Yes	Yes	No	Yes	Yes	No
12	Yes	Yes	Yes	Yes	Yes	Yes	No
Rear + Front slots + Front OCP							
5	Yes	No	No	No	Yes	No	Yes
8	Yes	Yes	No	No	Yes	No	Yes
Front slots + Rear OCP							
2	No	No	No	No	Yes	Yes	No

Slot ordering information

The following table lists the riser cards available for CTO builds and for field upgrades.

No slots: It is also possible to build a configuration without any slots, in which case slot fillers will be derived in the configurator. Slots can be added later as field upgrades using option part numbers as listed in the table.

Table 57. Riser cards

Part number	Feature code	Description	Slot configuration* (Green = Gen5, Blue = Gen4)			Purpose
			Slot 1	Slot 2	Slot 3	
Rear Riser 1 (FH slots)			Slot 1	Slot 2	Slot 3	
4XH7A82898	BPQU	ThinkSystem V3 2U x16/x8/x8 PCIe Gen5 Riser 1 or 2	Gen5 x16	Gen5 x8	Gen5 x8	3 slots PCIe 5.0
4XH7A82896	BLKL	ThinkSystem V3 2U x16/x8/x8 PCIe Gen4 Riser1 or 2	Gen4 x16	Gen4 x8	Gen4 x8	3 slots PCIe 4.0
4XH7A82900	BPQV	ThinkSystem V3 2U x16/x16/E PCIe Gen5 Riser1 or 2	Gen5 x16	Gen5 x16	No slot	2 slots PCIe 5.0; COM port or 7mm drives in slot 3

Part number	Feature code	Description	Slot configuration* (Green = Gen5, Blue = Gen4)				Purpose
4XH7A82892	BLKM	ThinkSystem V3 2U x16/x16/E PCIe Gen4 Riser1 or 2	Gen4 x16	Gen4 x16	No slot		2 slots PCIe 4.0; COM port or 7mm drives in slot 3
4XH7A82902	BPQW	ThinkSystem V3 2U E/x16/x16 PCIe Gen5 Riser1 or 2	No slot	Gen5 x16	Gen4 x16		PCIe 5.0 in slot 2; DW GPU in slot 2
4XH7A82894	BLKN	ThinkSystem V3 2U G4 E/x16/x16 PCIe Riser1 or 2	No slot	Gen4 x16	Gen4 x16		2 slots PCIe 4.0; DW GPU in slot 2
4XH7A82890	BLKP	ThinkSystem V3 2U x16 PCIe Gen4 Riser1 or 2	No slot	No slot	Gen4 x16		1 slot PCIe 4.0; For 4x 3.5-inch rear drives
Rear Riser 2 (FH slots)			Slot 4	Slot 5	Slot 6		
4XH7A82898	BPQU	ThinkSystem V3 2U x16/x8/x8 PCIe Gen5 Riser 1 or 2	Gen5 x16	Gen5 x8	Gen5 x8		3 slots PCIe 5.0
4XH7A82896	BLKL	ThinkSystem V3 2U x16/x8/x8 PCIe Gen4 Riser1 or 2	Gen4 x16	Gen4 x8	Gen4 x8		3 slots PCIe 4.0
4XH7A82900	BPQV	ThinkSystem V3 2U x16/x16/E PCIe Gen5 Riser1 or 2	Gen5 x16	Gen5 x16	No slot		2 slots PCIe 5.0; COM port or 7mm drives in slot 6
4XH7A82892	BLKM	ThinkSystem V3 2U x16/x16/E PCIe Gen4 Riser1 or 2	Gen4 x16	Gen4 x16	No slot		2 slots PCIe 4.0; COM port or 7mm drives in slot 6
4XH7A82902	BPQW	ThinkSystem V3 2U E/x16/x16 PCIe Gen5 Riser1 or 2	No slot	Gen5 x16	Gen4 x16		PCIe 5.0 in slot 5; DW GPU in slot 5
4XH7A82894	BLKN	ThinkSystem V3 2U G4 E/x16/x16 PCIe Riser1 or 2	No slot	Gen4 x16	Gen4 x16		2 slots PCIe 4.0; DW GPU in slot 5
4XH7A82890	BLKP	ThinkSystem V3 2U x16 PCIe Gen4 Riser1 or 2	No slot	No slot	Gen4 x16		1 slot PCIe 4.0; For 2x or 4x 3.5-inch rear drives

Part number	Feature code	Description	Slot configuration* (Green = Gen5, Blue = Gen4)				Purpose
Rear Riser 3 (2x FH slots)			Slot 7	Slot 8			
4XH7A85887	BLL9	ThinkSystem V3 2U x16/x16 PCIe Gen5 Riser3 Kit	Gen5 x16	Gen5 x16			2x PCIe 5.0 x16 slots; DW GPU in slot 7
4XH7A85885	BPKG	ThinkSystem V3 2U x16/x16 PCIe Gen4 Riser3 Kit with Cage	Gen4 x16	Gen4 x16			2x PCIe 4.0 x16 slots; DW GPU in slot 7
4XH7A85886	BPKH	ThinkSystem V3 2U x8/x8 PCIe Gen5 Riser3 Kit with Cage	Gen5 x8	Gen5 x8			2x PCIe 5.0 x8 slots
4XH7A85884	BPKF	ThinkSystem V3 2U x8/x8 PCIe Gen4 Riser3 Kit with Cage	Gen4 x8	Gen4 x8			2x PCIe 4.0 x8 slots
Rear Riser 3 & 4 (4x LP slots)			Slot 7	Slot 8	Slot 9	Slot 10	
4XH7A85888	BQ2W†	ThinkSystem V3 Rear PCIe Gen5 2x8 w/o Retimer HS Riser	Gen5 x8	Gen5 x8			2x PCIe 5.0 x8 slots
	BTMS†	ThinkSystem V3 2U PCIe Gen5 Riser 3/4 Option Kit			Gen5 x8	Gen4 x8	2x PCIe x8 slots (Gen 5, Gen4)
Front Riser			Slot 11	Slot 12			
4XH7A85889	BQ2X	ThinkSystem V3 2U Front x16/x16 PCIe G4 Riser	Gen4 x16	Gen4 x16			2x PCIe 4.0 x16 front-accessible slots

* All PCIe x8 slots are open ended and will physically support x16 adapters

† In the configurator, when feature BQ2W is selected, BTMS is automatically derived and provides slots 9 & 10. 4XH7A85888 contains both risers.

To configure the rear OCP slot, no additional feature codes are needed. To configure the front OCP slot, you will need the components listed in the following table. These components are used to route the rear OCP signals to the front of the server.

Tip: See the Slot combinations section to see which slot combinations are supported with the front and rear OCP slots

Table 58. Feature codes for the front OCP slot

Feature code	Description
BQ2E	ThinkSystem V3 1U/2U Front OCP Interposer Card
BQ2F*	ThinkSystem V3 1U/2U Rear OCP Interposer Card

* BQ2F is automatically derived when BQ2E is selected

Configuration rules:

- Riser 3 is not supported with the M.2 adapter
- Front PCIe slots are not supported with the M.2 adapter
- For best performance, install PCIe 5.0 adapters in PCIe 5.0 (Gen5) slots
- The server only supports one OCP slot, either in the rear of the server or the front of the server, not both
- If you want to configure 4x low profile slots for slots 7-10, select feature BQ2W which provides riser 3 (slots 7, 8). Feature BTMS will then be automatically derived to provide riser 4 (slots 9 & 10), along with the necessary cables. Option part number 4XH7A85888 contains both of these risers and the cables.
- If you want to add both a 7mm drive enclosure plus 2x PCIe slots above it, you will need to order the 7mm drive option (either 4XH7A85898 or 4XH7A85899) plus the x16/x16/E riser kit (4XH7A82900 for PCIe Gen 5 or 4XH7A82892 for Gen 4). The riser kit part number provides the 2-slot riser card.
- All PCIe x8 slots are open ended and will physically support x16 adapters

Serial port

The SR665 V3 optionally supports a RS-232 serial port by adding a COM port bracket to either slot 3 or slot 6. Ordering information is shown in the following table.

Front PCIe slots: The serial port is not supported in the front PCIe slots

Table 59. Serial port

Part number	Feature code	Description
4X97A82921	BMNJ	ThinkSystem V2/V3 1U COM Port Upgrade Kit

The bracket is shown in the following figure. The option part number includes both Low Profile and Full Height brackets.

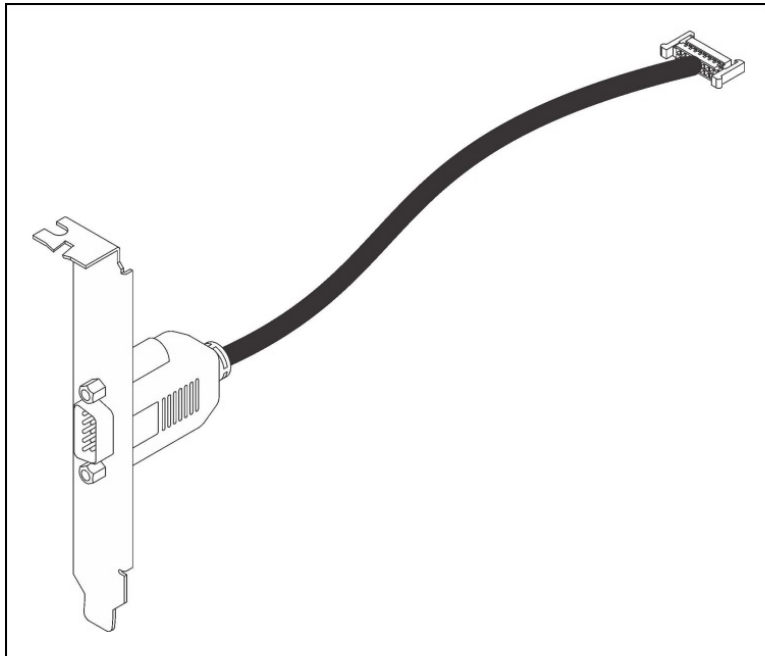

Figure 16. ThinkSystem V2/V3 1U COM Port Upgrade Kit

Network adapters

The server has a dedicated OCP 3.0 SFF slot with PCIe 5.0 x16 host interface. See [Figure 3](#) for the location of the OCP slot.

The following table lists the supported OCP adapters. One port can optionally be shared with the XCC management processor for Wake-on-LAN and NC-SI support. Only 1 OCP card can be installed in the server, either rear-accessible or front-accessible.

Table 60. Supported OCP adapters

Part number	Feature code	Description	Maximum supported	Windows 10/11 support
Gigabit Ethernet				
4XC7A08235	B5T1	ThinkSystem Broadcom 5719 1GbE RJ45 4-port OCP Ethernet Adapter	1	Supported
4XC7A08277	B93E	ThinkSystem Intel I350 1GbE RJ45 4-port OCP Ethernet Adapter	1	Supported
10 Gb Ethernet - 10GBASE-T				
4XC7A08236	B5ST	ThinkSystem Broadcom 57416 10GBASE-T 2-port OCP Ethernet Adapter	1	Supported
4XC7A08240	B5T4	ThinkSystem Broadcom 57454 10GBASE-T 4-port OCP Ethernet Adapter	1	Supported
4XC7A08278	BCD5	ThinkSystem Intel X710-T2L 10GBASE-T 2-port OCP Ethernet Adapter	1	Supported
4XC7A80268	BPPY	ThinkSystem Intel X710-T4L 10GBase-T 4-Port OCP Ethernet Adapter	1	Supported
25 Gb Ethernet				
4XC7A08237	BN2T	ThinkSystem Broadcom 57414 10/25GbE SFP28 2-Port OCP Ethernet Adapter	1	Supported
4XC7A80567	BPPW	ThinkSystem Broadcom 57504 10/25GbE SFP28 4-Port OCP Ethernet Adapter	1	Supported
4XC7A08294	BCD4	ThinkSystem Intel E810-DA2 10/25GbE SFP28 2-Port OCP Ethernet Adapter	1	Supported
4XC7A80269	BP8L	ThinkSystem Intel E810-DA4 10/25GbE SFP28 4-Port OCP Ethernet Adapter	1	Supported
4XC7A62582	BE4T	ThinkSystem Mellanox ConnectX-6 Lx 10/25GbE SFP28 2-Port OCP Ethernet Adapter	1	No
100 Gb Ethernet				
4XC7A08243	BPPX	ThinkSystem Broadcom 57508 100GbE QSFP56 2-Port OCP Ethernet Adapter	1	Supported

Configuration rules:

- The ThinkSystem Broadcom 5719 1GbE RJ45 4-port OCP Ethernet Adapter (4XC7A08235, B5T1) is currently not supported with the following CPUs. The incompatibility is planned to be resolved in a future update to XCC firmware in December 2023.
 - ThinkSystem AMD EPYC 9124 16C 200W 3.0GHz Processor
 - ThinkSystem AMD EPYC 9224 24C 200W 2.5GHz Processor
 - ThinkSystem AMD EPYC 9254 24C 200W 2.9GHz Processor
 - ThinkSystem AMD EPYC 9334 32C 210W 2.7GHz Processor

The following table lists additional supported network adapters that can be installed in the regular PCIe slots.

Table 61. Supported PCIe Network Adapters

Part number	Feature	Description	PCIe lanes	Max Qty	Slots supported	Windows 10/11 support
Gigabit Ethernet						
7ZT7A00484	AUZV	ThinkSystem Broadcom 5719 1GbE RJ45 4-Port PCIe Ethernet Adapter	Gen2 x4	10	1-12	Supported
7ZT7A00535	AUZW	ThinkSystem I350-T4 PCIe 1Gb 4-Port RJ45 Ethernet Adapter	Gen2 x4	10	1-12	Supported
10 Gb Ethernet - 10GBASE-T						
7ZT7A00496	AUKP	ThinkSystem Broadcom 57416 10GBASE-T 2-Port PCIe Ethernet Adapter	Gen3 x8	10	1-8,11,12	Supported
4XC7A08245	B5SU	ThinkSystem Broadcom 57454 10GBASE-T 4-port PCIe Ethernet Adapter	Gen3 x8	10	1-8,11,12	Supported
4XC7A80266	BNWL	ThinkSystem Intel X710-T2L 10GBase-T 2-Port PCIe Ethernet Adapter	Gen3 x8	10	1-12	Supported
4XC7A79699	BMXB	ThinkSystem Intel X710-T4L 10GBase-T 4-Port PCIe Ethernet Adapter	Gen3 x8	10	1-12	Supported
25 Gb Ethernet						
4XC7A08238	BK1H	ThinkSystem Broadcom 57414 10/25GbE SFP28 2-port PCIe Ethernet Adapter	Gen3 x8	10	1-12	Supported
4XC7A80566	BNWM	ThinkSystem Broadcom 57504 10/25GbE SFP28 4-Port PCIe Ethernet Adapter	Gen4 x16	6	1-8,11,12	Supported
4XC7A08295	BCD6	ThinkSystem Intel E810-DA2 10/25GbE SFP28 2-Port PCIe Ethernet Adapter	Gen4 x8	10	1-12	Supported
4XC7A80267	BP8M	ThinkSystem Intel E810-DA4 10/25GbE SFP28 4-Port PCIe Ethernet Adapter	Gen4 x16	6	1-8,11,12	Supported
4XC7A62580	BE4U	ThinkSystem Mellanox ConnectX-6 Lx 10/25GbE SFP28 2-Port PCIe Ethernet Adapter	Gen4 x8	10	1-12	No
100 Gb Ethernet / HDR100 InfiniBand						
4XC7A08297	BK1J	ThinkSystem Broadcom 57508 100GbE QSFP56 2-port PCIe 4 Ethernet Adapter	Gen4 x16	6	1,2,4,5,7,8,11,12	Supported
4XC7A08248	B8PP	ThinkSystem Mellanox ConnectX-6 Dx 100GbE QSFP56 2-port PCIe Ethernet Adapter	Gen4 x16	6	1,2,4,5,7,8,11,12	No
4C57A14177	B4R9	ThinkSystem Mellanox ConnectX-6 HDR100/100GbE QSFP56 1-port PCIe VPI Adapter	Gen4 x16	6	1,2,4,5,7,8,11,12	No
4C57A14178	B4RA	ThinkSystem Mellanox ConnectX-6 HDR100/100GbE QSFP56 2-port PCIe VPI Adapter	Gen4 x16	6	1,2,4,5,7,8,11,12	No
200 Gb Ethernet / HDR InfiniBand						
4C57A15326	B4RC	ThinkSystem Mellanox ConnectX-6 HDR/200GbE QSFP56 1-port PCIe 4 VPI Adapter	Gen4 x16	6	1,2,4,5,7,8,11,12	No
4XC7A81883	BQBN	ThinkSystem NVIDIA ConnectX-7 NDR200/HDR QSFP112 2-Port PCIe Gen5 x16 InfiniBand Adapter	Gen5 x16	6	1,2,4,5,7,8	No
400 Gb Ethernet / NDR InfiniBand						
4XC7A80289	BQ1N	ThinkSystem NVIDIA ConnectX-7 NDR400 OSFP 1-Port PCIe Gen5 Adapter	Gen5 x16	6	1,2,4,5,7,8	No

For more information, including the transceivers and cables that each adapter supports, see the list of Lenovo Press Product Guides in the Networking adapters category:

<https://lenovopress.com/servers/options/ethernet>

Configuration requirements:

- Adapters with a x16 host interface require a x16 slot to maximize performance
- PCIe Gen5 adapters will require a Gen5 riser to maximize performance
- **E810 Ethernet and X350 RAID/HBAs:** The use of both an Intel E810 network adapter and an X350 HBA/RAID adapter (9350, 5350 and 4350) is currently not supported in ThinkSystem servers. For details see [Support Tip HT513226](#). Planned support for this combination of adapters is 4Q/2023 (SI 23-2).
- The ThinkSystem Broadcom 5719 1GbE RJ45 4-Port PCIe Ethernet Adapter (7ZT7A00484, AUZV) is currently not supported with the following CPUs. The incompatibility is planned to be resolved in a future update to XCC firmware in December 2023.
 - ThinkSystem AMD EPYC 9124 16C 200W 3.0GHz Processor
 - ThinkSystem AMD EPYC 9224 24C 200W 2.5GHz Processor
 - ThinkSystem AMD EPYC 9254 24C 200W 2.9GHz Processor
 - ThinkSystem AMD EPYC 9334 32C 210W 2.7GHz Processor

Fibre Channel host bus adapters

The following table lists the Fibre Channel HBAs supported by the SR665 V3.

No Windows 10/11 support: None of the adapters listed in the table are supported with Windows 10 or Windows 11.

Table 62. Fibre Channel HBAs

Part number	Feature code	Description	PCIe lanes	Max qty	Slots supported
64 Gb Fibre Channel HBAs					
4XC7A77485	BLC1	ThinkSystem Emulex LPe36002 64Gb 2-port PCIe Fibre Channel Adapter	Gen4 x8	10	1-12
32 Gb Fibre Channel HBAs					
4XC7A76498	BJ3G	ThinkSystem Emulex LPe35000 32Gb 1-port PCIe Fibre Channel Adapter v2	Gen4 x8	10	1-12
4XC7A76525	BJ3H	ThinkSystem Emulex LPe35002 32Gb 2-port PCIe Fibre Channel Adapter v2	Gen4 x8	10	1-12
4XC7A08279	BA1G	ThinkSystem QLogic QLE2770 32Gb 1-Port PCIe Fibre Channel Adapter	Gen4 x8	10	1-12
4XC7A08276	BA1F	ThinkSystem QLogic QLE2772 32Gb 2-Port PCIe Fibre Channel Adapter	Gen4 x8	10	1-12
16 Gb Fibre Channel HBAs					
01CV840	ATZV	Emulex 16Gb Gen6 FC Dual-port HBA	Gen3 x8	10	1-12
01CV830	ATZU	Emulex 16Gb Gen6 FC Single-port HBA	Gen3 x8	10	1-12
01CV760	ATZC	QLogic 16Gb Enhanced Gen5 FC Dual-port HBA	Gen3 x8	10	1-12
01CV750	ATZB	QLogic 16Gb Enhanced Gen5 FC Single-port HBA	Gen3 x8	10	1-12

For more information, see the list of Lenovo Press Product Guides in the Host bus adapters category:
<https://lenovopress.com/servers/options/hba>

SAS adapters for external storage

The following table lists SAS HBAs and RAID adapters supported by SR665 V3 server for use with external storage.

No Windows 10/11 support: None of the adapters listed in the table are supported with Windows 10 or Windows 11.

Table 63. Adapters for external storage

Part number	Feature code	Description	PCIe lanes	Max qty	Slots supported
SAS HBAs					
4Y37A78837	BNWK	ThinkSystem 440-8e SAS/SATA PCIe Gen4 12Gb HBA	Gen4 x8	8	1 - 8,11,12**
4Y37A09724	B8P7	ThinkSystem 440-16e SAS/SATA PCIe Gen4 12Gb HBA	Gen4 x8	8	1 - 8,11,12**
External RAID adapters					
4Y37A78836	BNWJ	ThinkSystem RAID 940-8e 4GB Flash PCIe Gen4 12Gb Adapter	Gen4 x8	4	1 - 8,11,12**

* See below regarding supercap requirements

** When Riser 3 is full-height slots, slots 1-8 are supported; when Riser 3 is configured as low-profile slots, 8 & 10 are supported, but 7 & 9 are not.

For a comparison of the functions of the supported storage adapters, see the ThinkSystem RAID Adapter and HBA Reference:

<https://lenovopress.lenovo.com/lp1288#sr665-v3-support=SR665%2520V3&internal-or-external-ports=External>

The RAID 940-8e adapter uses a flash power module (supercap), which can be installed in one of up to 4 locations in the server depending on the server configuration. See the [RAID flash power module \(supercap\) support](#) section for details. The number of 940-8e RAID adapters supported is based on how many supercaps can be installed in the server. If an internal RAID adapter with flash power modules is installed, the maximum number of 940-8e adapters supported is reduced by 1.

For more information, see the list of Lenovo Press Product Guides in the Host bus adapters and RAID adapters categories:

<https://lenovopress.com/servers/options/hba>
<https://lenovopress.com/servers/options/raid>

Flash storage adapters

The SR665 V3 currently does not support PCIe Flash Storage adapters.

GPU adapters

This section describes the supported GPUs.

- [GPU part numbers](#)
- [Riser selections for double-wide GPUs](#)
- [GPU Enablement Kit](#)
- [GPU cable kits](#)

GPU part numbers

The SR665 V3 supports the following graphics processing units (GPUs).

Table 64. Supported GPUs

Part number	Feature code	Description	TDP	Aux power	PCIe lanes	Max qty	Slots supported	Windows 10/11 support
Double-wide GPUs								
4X67A81102	BP04	ThinkSystem AMD Instinct MI210 PCIe Gen4 Passive Accelerator	300W	Yes	Gen4 x16	3	2, 5, 7	No
4X67A82257	BR9U	ThinkSystem NVIDIA H100 80GB PCIe Gen5 Passive GPU	350W	Yes	Gen5 x16	3	2, 5, 7	No
4X67A76715	BLK1	ThinkSystem NVIDIA A100 80GB PCIe Gen4 Passive GPU	300W	Yes	Gen4 x16	3	2, 5, 7	No
CTO only	BQZP	ThinkSystem NVIDIA A100 80GB PCIe Gen4 Passive GPU w/o CEC	300W	Yes	Gen4 x16	3	2, 5, 7	No
4X67A72593	BQZQ	ThinkSystem NVIDIA A40 48GB PCIe Gen4 Passive GPU w/o CEC	300W	Yes	Gen4 x16	3	2, 5, 7	Supported
4X67A76581	BJHG	ThinkSystem NVIDIA A30 24GB PCIe Gen4 Passive GPU	165W	Yes	Gen4 x16	3	2, 5, 7	Supported
CTO only	BQZR	ThinkSystem NVIDIA A30 24GB PCIe Gen4 Passive GPU w/o CEC	165W	Yes	Gen4 x16	3	2, 5, 7	Supported
4X67A76727	BQZU	ThinkSystem NVIDIA A16 64GB Gen4 PCIe Passive GPU w/o CEC	250W	Yes	Gen4 x16	3	2, 5, 7	Supported
4X67A71310	BFT0	ThinkSystem NVIDIA RTX A6000 48GB PCIe Active GPU	300W	Yes	Gen4 x16	3	2, 5, 7	Supported
4X67A76726	BNFD	ThinkSystem NVIDIA RTX A4500 20GB PCIe Active GPU	200W	Yes	Gen4 x16	3	2, 5, 7	Supported
4X67A76720	BMT9	ThinkSystem NVIDIA RTX A2000 12GB PCIe Active GPU	70W	Yes	Gen4 x16	3	2, 5, 7	Supported
Single-wide GPUs								
4X67A81547	BP05	ThinkSystem NVIDIA A2 16GB PCIe Gen4 Passive GPU	60W	No	Gen4 x8	8	1 - 8	Supported
CTO only	BQZT	ThinkSystem NVIDIA A2 16GB PCIe Gen4 Passive GPU w/o CEC	60W	No	Gen4 x8	8	1 - 8	Supported

* When a double-wide GPU is installed in slot 2, 5 or 7, the adjacent slot 1, 4 and 8 respectively is not available

For information about these GPUs, see the ThinkSystem GPU Summary, available at: <https://lenovopress.com/lp0768-thinksystem-thinkagile-gpu-summary>

For CTO orders, the SR665 V3 also supports the selection of a "virtual GPU" or placeholder GPU. This selection allows for "GPU ready" configurations; It ensures that the server ships with the components needed for GPU installation (GPU power cables, air ducts, power supplies, fans, etc) without actually including the GPUs themselves. The following table lists the ordering information for CTO orders.

Table 65. Virtual GPU ordering information

Part number	Feature code	Description
CTO only	BW40	ThinkSystem NVIDIA A4500 GPU-Ready Installation
CTO only	BVLL	ThinkSystem NVIDIA H100 GPU-Ready Installation
CTO only	BP4X	ThinkSystem DW GPU-Ready Installation (for all other supported DW GPUs)

Configuration rules

The following configuration requirements must be met when installing GPUs:

- Some NVIDIA A Series GPUs are available as two feature codes, one with a CEC chip and one without a CEC chip (ones without the CEC chip have "w/o CEC" in the name). The CEC is a secondary Hardware Root of Trust (RoT) module that provides an additional layer of security, which can be used by customers who have high regulatory requirements or high security standards. NVIDIA uses a multi-layered security model and hence the protection offered by the primary Root of Trust embedded in the GPU is expected to be sufficient for most customers. The CEC defeatured products still offer Secure Boot, Secure Firmware Update, Firmware Rollback Protection, and In-Band Firmware Update Disable. Specifically, without the CEC chip, the GPU does not support Key Revocation or Firmware Attestation. CEC and non-CEC GPUs of the same type of GPU can be mixed in field upgrades.
- All GPUs installed must be identical
- When a double-wide GPU is installed in slot 2, 5 or 7, the adjacent slot 1, 4 and 8 respectively is not available
- Flash storage adapters are not supported.
- Middle drive bays and Rear drive bays are not supported
- For details regarding supported combinations of front drive bays, processors, fans, and ambient temperature, see the Thermal Rules page of the User Guide:
https://pubs.lenovo.com/sr665-v3/thermal_rules#gpu-configurations

Riser selections for double-wide GPUs

When a double-wide GPU is installed in slot 2, 5 or 7, the adjacent slot 1, 4 and 8 respectively is not available. The riser cards listed in the following table are used with double-wide GPUs.

Table 66. Risers needed for double-wide GPUs

Riser	Part number	Feature code	Description
Riser 1 (GPU in slot 2) - PCIe Gen5	4XH7A82902	BPQW	ThinkSystem V3 2U E/x16/x16 PCIe Gen5 Riser1 or 2
Riser 1 (GPU in slot 2) - PCIe Gen4	4XH7A82894	BLKN	ThinkSystem V3 2U G4 E/x16/x16 PCIe Riser1 or 2
Riser 2 (GPU in slot 5) - PCIe Gen5	4XH7A82902	BPQW	ThinkSystem V3 2U E/x16/x16 PCIe Gen5 Riser1 or 2
Riser 2 (GPU in slot 5) - PCIe Gen4	4XH7A82894	BLKN	ThinkSystem V3 2U G4 E/x16/x16 PCIe Riser1 or 2
Riser 3 (GPU in slot 7) - PCIe Gen5	4XH7A85887	BLL9	ThinkSystem V3 2U x16/x16 PCIe Gen5 Riser3 Kit
Riser 3 (GPU in slot 7) - PCIe Gen4	4XH7A85885	BPKG	ThinkSystem V3 2U x16/x16 PCIe Gen4 Riser3 Kit with Cage

GPU Enablement Kit

When installing any full-length GPU as a field upgrade, you will also need to order the GPU Enablement Kit as listed in the following table. This kit is not required for the NVIDIA A2 GPU.

Table 67. ThinkSystem SR665 V3 GPU Full Length Thermal Option Kit

Part number	Description	Maximum supported
4X67A85856	ThinkSystem SR665 V3 GPU Full Length Thermal Option Kit <ul style="list-style-type: none"> • 2x 1U processor performance heatsinks - replace existing 2U heatsinks (SBB7A54175) • 1x ThinkSystem 2U GPU air duct - replaces main air baffle (SBB7A54054) • 3x GPU extend air ducts - needed in a zone if an A10 or other single-wide GPU > 75W is installed in the upper slot (SBB7A43702) • 3x Air duct fillers - needed in each riser zone if no GPU is installed in that zone (SBB7A54052) • 3x 8-pin GPU power cables for double-wide GPUs (SBB7A49792) • 3x 16-pin GPU power cables for double-wide GPUs (SBB7A66338) • 3x GPU power cables for single-wide GPUs (SBB7A44786) • 3x GPU power Y-cables when 2x single-wide GPUs installed on one riser (SBB7A23757) 	1

The following figure shows the GPU air duct with GPU air duct fillers and GPU extend air ducts installed. Note that the drawings might not 100% reflect the shipping components.

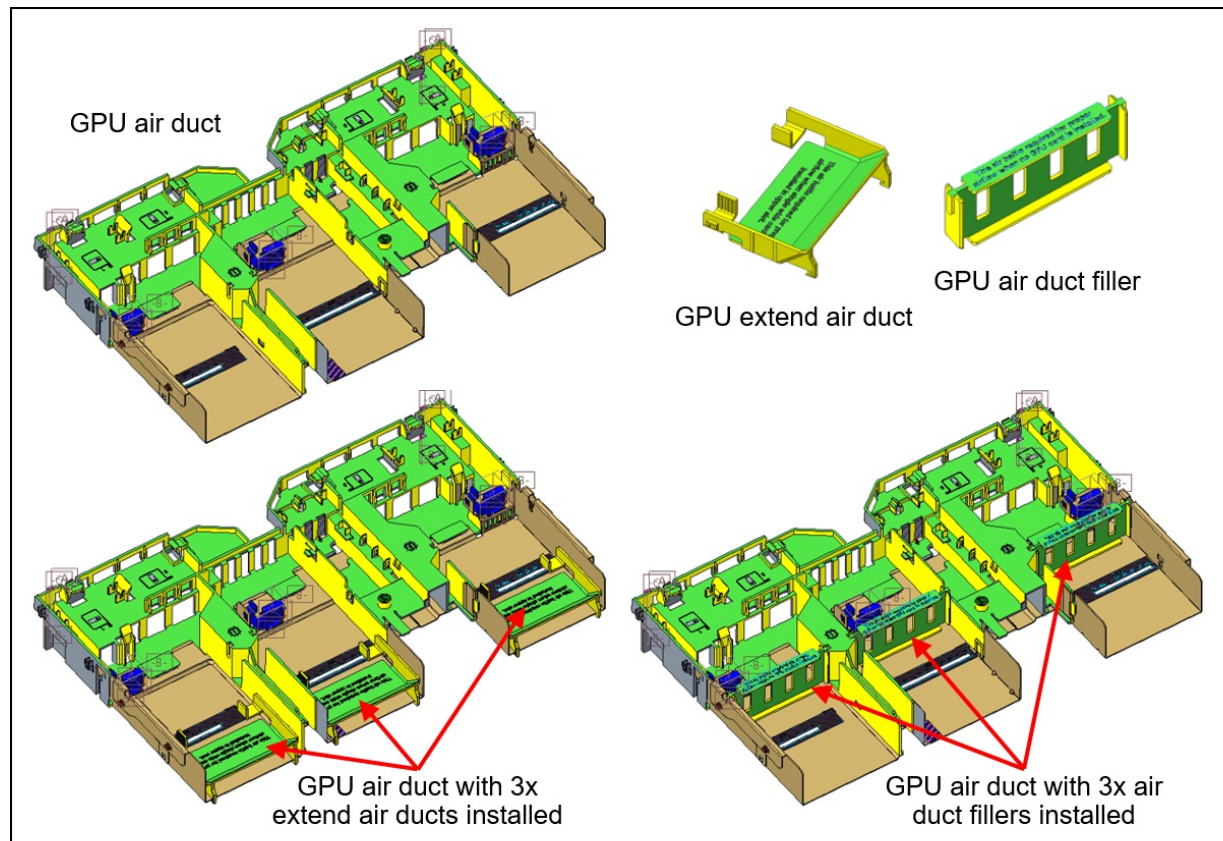

Figure 17. SR665 V3 GPU air duct

GPU cable kits

The following cable kits are offered to provide auxiliary power cables for GPUs that require one. See the [Supported GPUs table](#) to see which GPUs require an auxiliary power cable.

Configuration notes:

- This cable kits are only required for field upgrades; factory (CTO) orders will automatically include any required cables.
- For double-wide GPUs, The DW (double-wide) cable kit is only required if you are adding *additional* double-wide GPUs to a server that already has a DW GPU installed from a CTO order. If you are doing a field upgrade to install the *first* DW GPU to a server, order the ThinkSystem SR665 V3 GPU Full Length Thermal Option Kit, 4X67A85856 instead, since the Enablement Kit includes the necessary power cables.
- The SW (single-wide) cable kit is required if you are doing any field upgrades to add a single-wide GPU that requires an auxiliary power cable (GPU power > 75 W), however, all currently supported GPUs do *not* require auxiliary power cables.

Table 68. GPU cable kits

Part number	Description
4X97A86165	ThinkSystem SR665 V3/SR655 V3 DW GPU Cable Option Kit <ul style="list-style-type: none">• 3x Power cables for double-wide GPU (SBB7A49792)
4X97A86166	ThinkSystem SR665 V3/SR655 V3 SW GPU Cable Option Kit <ul style="list-style-type: none">• 3x Power cables for single-wide GPU (SBB7A44786)• 3x Power Y-cable when 2x single-wide GPUs installed on one riser (SBB7A23757)

Cooling

The SR665 V3 server has up to six 60 mm hot-swap variable-speed fans. Five fans are needed when one processor is installed and six fans are required when two processors are installed. The server offers N+1 redundancy. The server also has one or two additional fans integrated in each of the two power supplies.

Depending on the configuration, the server will need either Standard fans (single-rotor 17K RPM) or Performance fans (dual-rotor 20K RPM).

Under all of the following conditions, standard fans can be used:

- CPUs have a TDP < 240W
- No GPUs
- No Mellanox ConnectX-6 or ConnectX-7 adapters
- No Broadcom 57454 10GBASE-T 4-port OCP adapter
- No 3DS RDIMMs
- No front 12x 3.5-inch drive bays
- No mid-chassis drive bays
- No rear drive bays

If any conditions are not met, Performance fans are required.

Ordering information for the fans is listed in the following table.

Table 69. Fan ordering information

Part number	Feature code	Description	Quantity required
4F17A14497	BH8F	ThinkSystem V3 2U Standard Fan Option Kit	1x CPU: 5 2x CPUs: 6
4F17A82884	BLL6	ThinkSystem V3 2U Performance Fan Option Kit	1x CPU: 5 2x CPUs: 6

Power supplies

The SR665 V3 supports up to two redundant hot-swap power supplies.

The power supply choices are listed in the following table. Both power supplies used in server must be identical.

Tip: When configuring a server in the DCSC configurator, power consumption is calculated precisely by interfacing with Lenovo Capacity Planner. You can therefore select the appropriate power supply for your configuration. However, do consider future upgrades that may require additional power needs.

Table 70. Power supply options

Part number	Feature code	Description	Connector	Max quantity	110V AC	220V AC	240V DC PRC only	-48V DC
AC input power - 80 PLUS Titanium efficiency								
4P57A82019	BR1X	ThinkSystem 750W 230V Titanium Hot-Swap Gen2 Power Supply v3	C13	2	No	Yes	Yes	No
4P57A72666	BLKH	ThinkSystem 1100W 230V Titanium Hot-Swap Gen2 Power Supply	C13	2	No	Yes	Yes	No
4P57A78359	BPK9	ThinkSystem 1800W 230V Titanium Hot-Swap Gen2 Power Supply	C13	2	No	Yes	Yes	No
4P57A72667	BKTJ	ThinkSystem 2600W 230V Titanium Hot-Swap Gen2 Power Supply	C19	2	No	Yes	Yes	No
AC input power - 80 PLUS Platinum efficiency								
4P57A72670	BNFG	ThinkSystem 750W 230V/115V Platinum Hot-Swap Gen2 Power Supply v3	C13	2	Yes	Yes	Yes	No
4P57A72671	BNFH	ThinkSystem 1100W 230V/115V Platinum Hot-Swap Gen2 Power Supply v3	C13	2	Yes	Yes	Yes	No
4P57A26294	BMUF	ThinkSystem 1800W 230V Platinum Hot-Swap Gen2 Power Supply v2	C13	2	No	Yes	Yes	No
4P57A26295	B962	ThinkSystem 2400W 230V Platinum Hot-Swap Gen2 Power Supply	C19	2	No	Yes	Yes	No
-48V DC input power								
4P57A26296	B8QE	ThinkSystem 1100W -48V DC Hot-Swap Gen2 Power Supply	DC	2	No	No	No	Yes

Supported power supplies are auto-sensing dual-voltage units, supporting both 110V AC (100-127V 50/60 Hz) and 220V AC (200-240V 50/60 Hz) power. For China customers, all power supplies support 240V DC.

AC power supplies up to 1800W have a C14 connector. AC power supplies 2400W and above have a C19 connector.

The supported -48V DC power supply has a Weidmuller TOP 4GS/3 7.6 terminal as shown in the following figure.

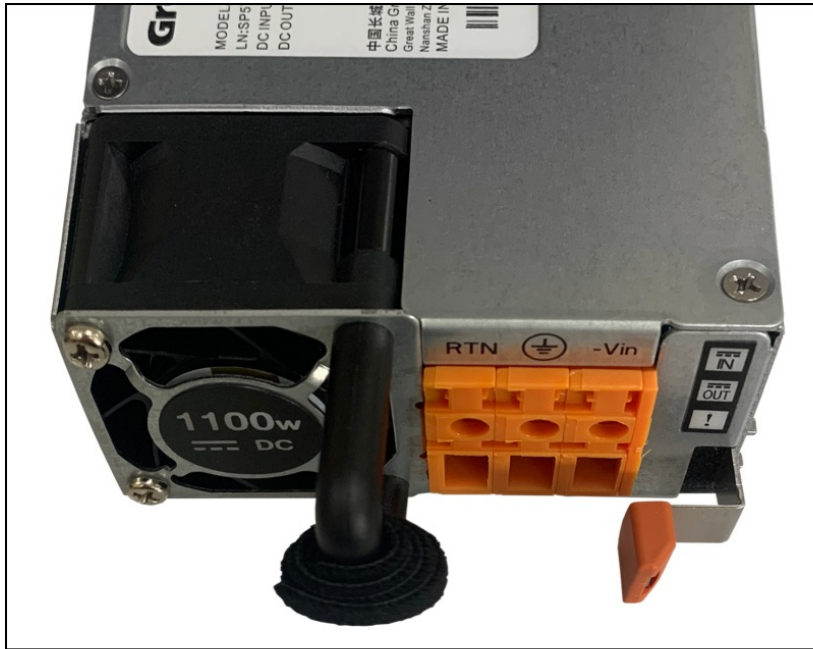

Figure 18. Connector on the ThinkSystem 1100W -48V DC Hot-Swap Gen2 Power Supply

Power supply options do not include a line cord. For server configurations, the inclusion of a power cord is model dependent. Configure-to-order models can be configured without power cords if desired.

Power supply LEDs

The supported hot-swap power supplies have the following LEDs:

- Power input LED:
 - Green: The power supply is connected to the AC power source
 - Off: The power supply is disconnected from the AC power source or a power problem has occurred
- Power output LED:
 - Green: The server is on and the power supply is working normally
 - Blinking green: The power supply is in Zero-output/Standby mode (see below)
 - Off: The server is powered off, or the power supply is not working properly
- Power supply error LED:
 - Off: The power supply is working normally
 - Yellow: The power supply has failed

Zero-output mode: When Zero-output mode (also known as Standby mode or Cold Redundancy mode) is configured in XCC and the server power load is sufficiently low, one of the installed power supplies enters into the Standby state while the other one delivers entire load. When the power load increases, the standby power supply will switch to Active state to provide sufficient power to the server. Zero-output mode can be enabled or disabled in the XClarity Controller web interface, Server Configuration > Power Policy. If you select Disable, then both power supplies will be in the Active state.

Power cords

Line cords and rack power cables with C13 connectors can be ordered as listed in the following table.

110V customers: If you plan to use the 1100W power supply with a 110V power source, select a power cable that is rated above 10A. Power cables that are rated at 10A or below are not supported with 110V power.

Table 71. Power cords

Part number	Feature code	Description
Rack cables - C13 to C14		
SL67B08593	BPHZ	0.5m, 10A/100-250V, C13 to C14 Jumper Cord
00Y3043	A4VP	1.0m, 10A/100-250V, C13 to IEC 320-C14 Rack Power Cable
4L67A08367	B0N5	1.0m, 13A/100-250V, C13 to C14 Jumper Cord
39Y7937	6201	1.5m, 10A/100-250V, C13 to IEC 320-C14 Rack Power Cable
4L67A08368	B0N6	1.5m, 13A/100-250V, C13 to C14 Jumper Cord
4L67A08365	B0N4	2.0m, 10A/100-250V, C13 to IEC 320-C14 Rack Power Cable
4L67A08369	6570	2.0m, 13A/100-250V, C13 to C14 Jumper Cord
4L67A08366	6311	2.8m, 10A/100-250V, C13 to IEC 320-C14 Rack Power Cable
4L67A08370	6400	2.8m, 13A/100-250V, C13 to C14 Jumper Cord
39Y7932	6263	4.3m, 10A/100-250V, C13 to IEC 320-C14 Rack Power Cable
4L67A08371	6583	4.3m, 13A/100-250V, C13 to C14 Rack Power Cable
Rack cables - C13 to C14 (Y-cable)		
00Y3046	A4VQ	1.345m, 2X C13 to C14 Jumper Cord, Rack Power Cable
00Y3047	A4VR	2.054m, 2X C13 to C14 Jumper Cord, Rack Power Cable
Rack cables - C13 to C20		
39Y7938	6204	2.8m, 10A/100-250V, C13 to IEC 320-C20 Rack Power Cable
Rack cables - C13 to C20 (Y-cable)		
47C2491	A3SW	1.2m, 16A/100-250V, 2 Short C13s to Short C20 Rack Power Cable
47C2492	A3SX	2.5m, 16A/100-250V, 2 Long C13s to Short C20 Rack Power Cable
47C2493	A3SY	2.8m, 16A/100-250V, 2 Short C13s to Long C20 Rack Power Cable
47C2494	A3SZ	4.1m, 16A/100-250V, 2 Long C13s to Long C20 Rack Power Cable
Line cords		
39Y7930	6222	2.8m, 10A/250V, C13 to IRAM 2073 (Argentina) Line Cord
81Y2384	6492	4.3m 10A/220V, C13 to IRAM 2073 (Argentina) Line Cord
39Y7924	6211	2.8m, 10A/250V, C13 to AS/NZ 3112 (Australia/NZ) Line Cord
81Y2383	6574	4.3m, 10A/230V, C13 to AS/NZS 3112 (Aus/NZ) Line Cord
69Y1988	6532	2.8m, 10A/250V, C13 to NBR 14136 (Brazil) Line Cord
81Y2387	6404	4.3m, 10A/250V, C13 - 2P+Gnd (Brazil) Line Cord
39Y7928	6210	2.8m, 220-240V, C13 to GB 2099.1 (China) Line Cord
81Y2378	6580	4.3m, 10A/220V, C13 to GB 2099.1 (China) Line Cord
39Y7918	6213	2.8m, 10A/250V, C13 to DK2-5a (Denmark) Line Cord
81Y2382	6575	4.3m, 10A/230V, C13 to DK2-5a (Denmark) Line Cord
39Y7917	6212	2.8m, 10A/230V, C13 to CEE7-VII (Europe) Line Cord

Part number	Feature code	Description
81Y2376	6572	4.3m, 10A/230V, C13 to CEE7-VII (Europe) Line Cord
39Y7927	6269	2.8m, 10A/250V, C13(2P+Gnd) (India) Line Cord
81Y2386	6567	4.3m, 10A/240V, C13 to IS 6538 (India) Line Cord
39Y7920	6218	2.8m, 10A/250V, C13 to SI 32 (Israel) Line Cord
81Y2381	6579	4.3m, 10A/230V, C13 to SI 32 (Israel) Line Cord
39Y7921	6217	2.8m, 220-240V, C13 to CEI 23-16 (Italy/Chile) Line Cord
81Y2380	6493	4.3m, 10A/230V, C13 to CEI 23-16 (Italy/Chile) Line Cord
46M2593	A1RE	2.8m, 12A/125V, C13 to JIS C-8303 (Japan) Line Cord
4L67A08362	6495	4.3m, 12A/200V, C13 to JIS C-8303 (Japan) Line Cord
39Y7926	6335	4.3m, 12A/100V, C13 to JIS C-8303 (Japan) Line Cord
39Y7922	6214	2.8m, 10A/250V, C13 to SABS 164 (S Africa) Line Cord
81Y2379	6576	4.3m, 10A/230V, C13 to SABS 164 (South Africa) Line Cord
39Y7925	6219	2.8m, 220-240V, C13 to KETI (S Korea) Line Cord
81Y2385	6494	4.3m, 12A/220V, C13 to KSC 8305 (S. Korea) Line Cord
39Y7919	6216	2.8m, 10A/250V, C13 to SEV 1011-S24507 (Swiss) Line Cord
81Y2390	6578	4.3m, 10A/230V, C13 to SEV 1011-S24507 (Sws) Line Cord
23R7158	6386	2.8m, 10A/125V, C13 to CNS 10917-3 (Taiwan) Line Cord
81Y2375	6317	2.8m, 10A/240V, C13 to CNS 10917-3 (Taiwan) Line Cord
81Y2374	6402	2.8m, 13A/125V, C13 to CNS 60799 (Taiwan) Line Cord
4L67A08363	AX8B	4.3m, 10A 125V, C13 to CNS 10917 (Taiwan) Line Cord
81Y2389	6531	4.3m, 10A/250V, C13 to 76 CNS 10917-3 (Taiwan) Line Cord
81Y2388	6530	4.3m, 13A/125V, C13 to CNS 10917 (Taiwan) Line Cord
39Y7923	6215	2.8m, 10A/250V, C13 to BS 1363/A (UK) Line Cord
81Y2377	6577	4.3m, 10A/230V, C13 to BS 1363/A (UK) Line Cord
90Y3016	6313	2.8m, 10A/120V, C13 to NEMA 5-15P (US) Line Cord
46M2592	A1RF	2.8m, 10A/250V, C13 to NEMA 6-15P Line Cord
00WH545	6401	2.8m, 13A/120V, C13 to NEMA 5-15P (US) Line Cord
4L67A08359	6370	4.3m, 10A/125V, C13 to NEMA 5-15P (US) Line Cord
4L67A08361	6373	4.3m, 10A/250V, C13 to NEMA 6-15P (US) Line Cord
4L67A08360	AX8A	4.3m, 13A/120V, C13 to NEMA 5-15P (US) Line Cord

Power cords (C19 connectors)

Line cords and rack power cables with C19 connectors can be ordered as listed in the following table.

Table 72. Power cords (C19 connectors)

Part number	Feature code	Description
Rack cables		
4L67A86677	BPJ0	0.5m, 16A/100-250V, C19 to IEC 320-C20 Rack Power Cable
4L67A86678	B4L0	1.0m, 16A/100-250V, C19 to IEC 320-C20 Rack Power Cable
4L67A86679	B4L1	1.5m, 16A/100-250V, C19 to IEC 320-C20 Rack Power Cable
4L67A86680	B4L2	2.0m, 16A/100-250V, C19 to IEC 320-C20 Rack Power Cable

Part number	Feature code	Description
39Y7916	6252	2.5m, 16A/100-240V, C19 to IEC 320-C20 Rack Power Cable
4L67A86681	B4L3	4.3m, 16A/100-250V, C19 to IEC 320-C20 Rack Power Cable
Line cords		
40K9777	6276	4.3m, 220-240V, C19 to IRAM 2073 (Argentina) Line cord
40K9773	6284	4.3m, 220-240V, C19 to AS/NZS 3112 (Aus/NZ) Line cord
40K9775	6277	4.3m, 250V, C19 to NBR 14136 (Brazil) Line Cord
40K9774	6288	4.3m, 220-240V, C19 to GB2099.1 (China) Line cord
40K9769	6283	4.3m, 16A/230V, C19 to IEC 309-P+N+G (Den/Sws) Line Cord
40K9766	6279	4.3m, 220-240V, C19 to CEE7-VII (European) Line cord
40K9776	6285	4.3m, 220-240V, C19 to IS6538 (India) Line cord
40K9771	6282	4.3m, 220-240V, C19 to SI 32 (Israel) Line cord
40K9768	6281	4.3m, 220-240V, C19 to CEI 23-16 (Italy) Line cord
40K9770	6280	4.3m, 220-240V, C19 to SABS 164 (South Africa) Line cord
41Y9231	6289	4.3m, 15A/250V, C19 to KSC 8305 (S. Korea) Line Cord
81Y2391	6549	4.3m, 16A/230V, C19 to SEV 1011 (Sws) Line Cord
41Y9230	6287	4.3m, 16A/250V, C19 to CNS 10917-3 (Taiwan) Line Cord
40K9767	6278	4.3m, 220-240V, C19 to BS 1363/A w/13A fuse (UK) Line Cord
40K9772	6275	4.3m, 16A/208V, C19 to NEMA L6-20P (US) Line Cord
00D7197	A1NV	4.3m, 15A/250V, C19 to NEMA 6-15P (US) Line Cord

-48V DC power cord

For the -48V DC Power Supply, the following power cable is supported.

Table 73. -48V DC power cable

Part number	Feature code	Description
4X97A59831	BE4V	2.5m, -48VDC Interconnecting Cable

Systems management

The SR665 V3 contains an integrated service processor, XClarity Controller 2 (XCC), which provides advanced control, monitoring, and alerting functions. The XCC2 is based on the AST2600 baseboard management controller (BMC) using a dual-core ARM Cortex A7 32-bit RISC service processor running at 1.2 GHz.

Topics in this section:

- [System I/O Board](#)
- [Local management](#)
- [System status with XClarity Mobile](#)
- [Remote management](#)
- [XCC2 Platinum](#)
- [Lenovo XClarity Provisioning Manager](#)
- [Lenovo XClarity Administrator](#)
- [Lenovo XClarity Integrators](#)
- [Lenovo XClarity Essentials](#)
- [Lenovo XClarity Energy Manager](#)
- [Lenovo Capacity Planner](#)

System I/O Board

The SR665 V3 implements a separate System I/O Board that connects to the Processor Board. The location of the System I/O Board is shown in the [Components and connectors](#) section. The System I/O Board contains all the connectors visible at the rear of the server as shown in the following figure.

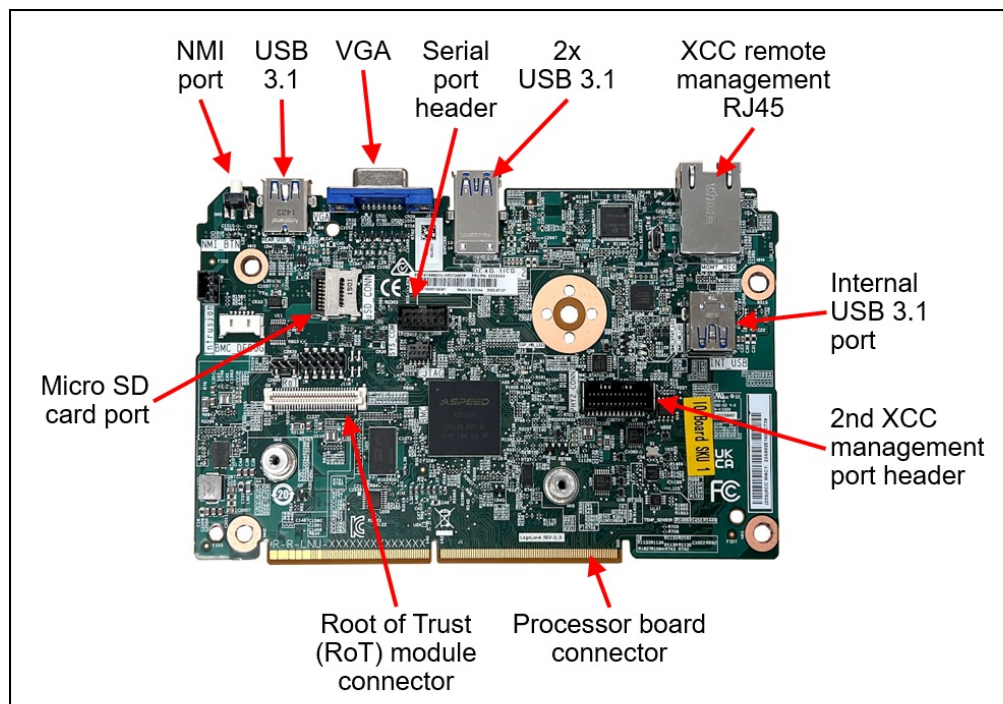

Figure 19. System I/O Board

The board also has the following components:

- XClarity Controller 2, implemented using the ASPEED AST2600 baseboard management controller (BMC).
- Root of Trust (RoT) module - a daughter card that implements Platform Firmware Resiliency (PFR)

hardware Root of Trust (RoT) which enables the server to be NIST SP800-193 compliant. For more details about PFR, see the [Security](#) section.

- Connector to enable an additional redundant Ethernet connection to the XCC2 controller. The connector is used in conjunction with the ThinkSystem Redundant System Management Port Adapter. For details, see the [Remote management](#) section.
- Internal USB port - to allow the booting of an operating system from a USB key. The VMware ESXi preloads use this port for example. Preloads are described in the [Operating system support](#) section.
- MicroSD card port to enable the use of a MicroSD card for additional storage for use with the XCC2 controller. XCC2 can use the storage as a Remote Disc on Card (RDOC) device (up to 4GB of storage). It can also be used to store firmware updates (including N-1 firmware history) for ease of deployment.

Tip: Without a MicroSD card installed, the XCC2 controller will have 100MB of available RDOC storage.

Ordering information for the supported USB drive and Micro SD card are listed in the following table.

Table 74. Media for use with the System I/O Board

Part number	Feature code	Description
4X77A77065	BNWN	ThinkSystem USB 32GB USB 3.0 Flash Drive
4X77A77064	BNWP	ThinkSystem MicroSD 32GB Class 10 Flash Memory Card

Local management

The SR665 V3 offers a front operator panel with key LED status indicators, as shown in the following figure.

Tip: The Network LED only shows network activity of the installed OCP network adapter.

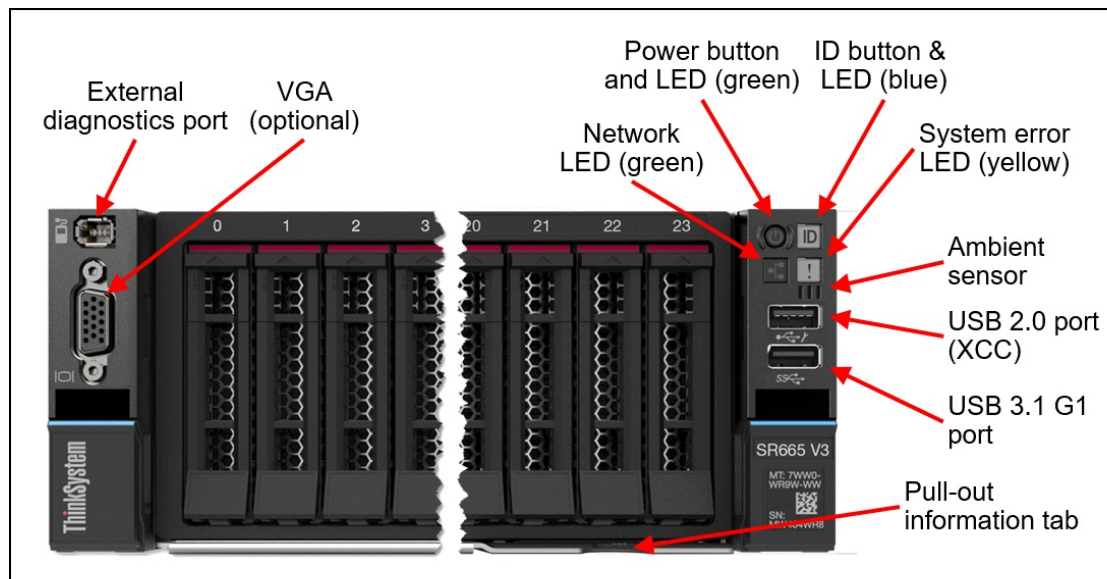

Figure 20. Front operator controls are on the left and right side of the server

Light path diagnostics

The server offers light path diagnostics. If an environmental condition exceeds a threshold or if a system component fails, XCC lights LEDs inside the server to help you diagnose the problem and find the failing part. The server has fault LEDs next to the following components:

- Each memory DIMM
- Each drive bay
- Each power supply

Front VGA and External Diagnostics ports

The VGA port at the rear of the server is included in all models, however the VGA port at the front of the server is optional. Also optional is the External Diagnostics port which enables the use of the External Diagnostics Handset.

To configure either the VGA port or the External Diagnostics port at the front of the server, select one of the following feature codes when configuring the server.

Table 75. Front VGA port

Part number	Feature code	Description	Front VGA port	External diagnostics port
CTO only	BQQ2	ThinkSystem 2U V3 EIA Latch Standard	No	No
4XH7A86164	BQQ1	ThinkSystem 2U V3 EIA Latch with VGA & External Diagnostics Ports	Included	Included
4XH7A86816	BQQ4	ThinkSystem 2U V3 EIA Latch with External Diagnostics Port	No	Included
4XH7A86817	BQQ3	ThinkSystem 2U V3 EIA Latch with VGA Port	Included	No

External Diagnostics Handset

The SR665 V3 optionally has a port to connect an External Diagnostics Handset as described in the preceding section. The External Diagnostics Handset has the same functions as the Integrated Diagnostics Panel but has the advantages of not consuming space on the front of the server plus it can be shared among many servers in your data center. The handset has a magnet on the back of it to allow you to easily mount it on a convenient place on any rack cabinet.

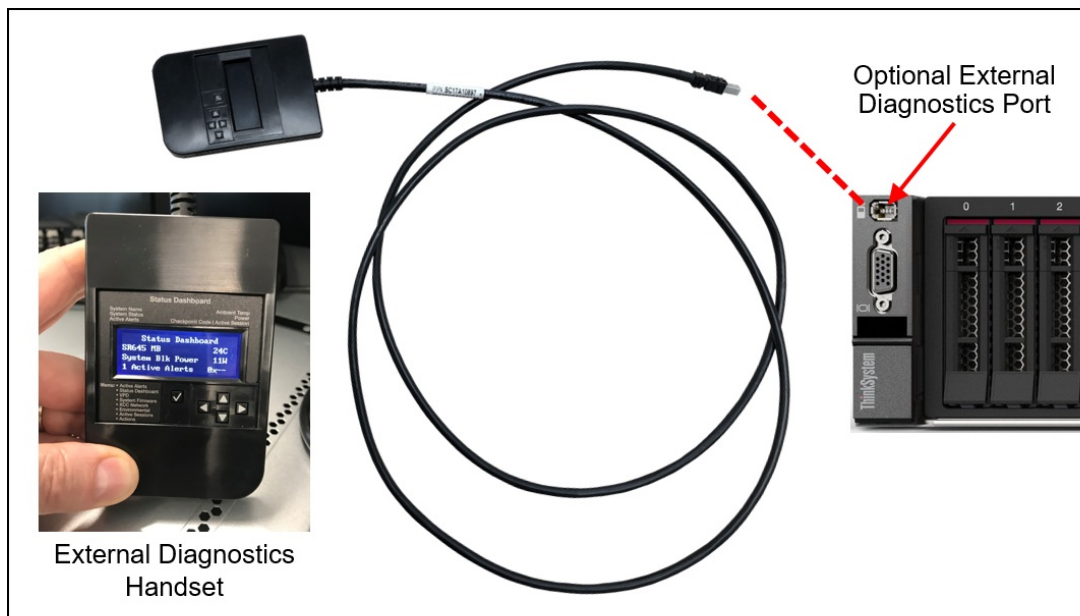

Figure 21. External Diagnostics Handset

Ordering information for the External Diagnostics Handset with is listed in the following table.

Table 76. External Diagnostics Handset ordering information

Part number	Feature code	Description
4TA7A64874	BEUX	ThinkSystem External Diagnostics Handset

Integrated Diagnostics Panel for 8x 2.5-inch and 16x 2.5-inch drive bay configurations

For configurations with 8x 2.5-inch or 16x 2.5-inch drive bays at the front, the server can optionally be configured to have a pull-out Integrated Diagnostics Panel. The following figure shows the standard (fixed) operator panel and the optional Integrated Diagnostics Panel.

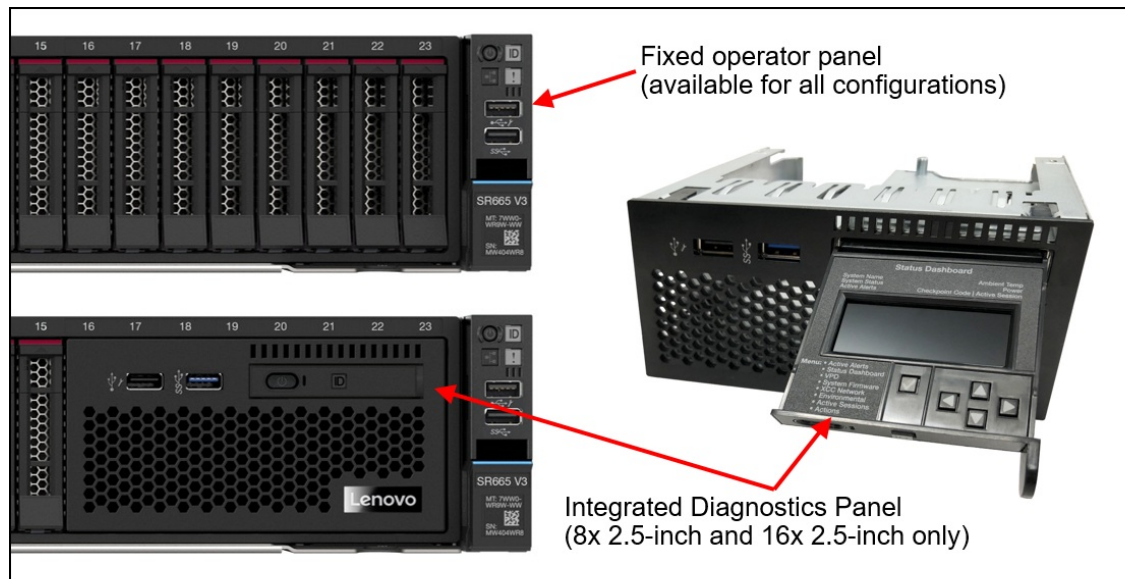

Figure 22. Operator panel choices for the 8x 2.5-inch drive bay configuration

The Integrated Diagnostics Panel allows quick access to system status, firmware, network, and health information. The LCD display on the panel and the function buttons give you access to the following information:

- Active alerts
- Status Dashboard
- System VPD: machine type & mode, serial number, UUID string
- System firmware levels: UEFI and XCC firmware
- XCC network information: hostname, MAC address, IP address, DNS addresses
- Environmental data: Ambient temperature, CPU temperature, AC input voltage, estimated power consumption
- Active XCC sessions
- System reset action

The Integrated Diagnostics Panel can be configured as listed in the following table. It is only available configure-to-order (CTO); not available as a field upgrade.

Table 77. Ordering information for the Integrated Diagnostics Panel

Part number	Feature code	Description
CTO only	BMJA	ThinkSystem 2U 16x2.5" Front Operator Panel v2

Information pull-out tab

The front of the server also houses an information pull-out tab (also known as the network access tag). See [Figure 2](#) for the location. A label on the tab shows the network information (MAC address and other data) to remotely access the service processor.

System status with XClarity Mobile

The XClarity Mobile app includes a tethering function where you can connect your Android or iOS device to the server via USB to see the status of the server.

The steps to connect the mobile device are as follows:

1. Enable USB Management on the server, by holding down the ID button for 3 seconds (or pressing the dedicated USB management button if one is present)
2. Connect the mobile device via a USB cable to the server's USB port with the management symbol 
3. In iOS or Android settings, enable Personal Hotspot or USB Tethering
4. Launch the Lenovo XClarity Mobile app

Once connected you can see the following information:

- Server status including error logs (read only, no login required)
- Server management functions (XClarity login credentials required)

Remote management

The server offers a dedicated RJ45 port at the rear of the server for remote management via the XClarity Controller management processor. The port supports 10/100/1000 Mbps speeds.

Remote server management is provided through industry-standard interfaces:

- Intelligent Platform Management Interface (IPMI) Version 2.0
- Simple Network Management Protocol (SNMP) Version 3 (no SET commands; no SNMP v1)
- Common Information Model (CIM-XML)
- Representational State Transfer (REST) support
- Redfish support (DMTF compliant)
- Web browser - HTML 5-based browser interface (Java and ActiveX not required) using a responsive design (content optimized for device being used - laptop, tablet, phone) with NLS support

The SR665 V3 also supports the use of an OCP adapter that provides an additional redundant Ethernet connection to the XCC2 controller. Ordering information is listed in the following table.

Table 78. Redundant System Management Port Adapter

Part number	Feature code	Description	Maximum quantity
4XC7A85319	BTMQ	ThinkSystem V3 Management NIC Adapter Kit	1

The use of this adapter allows concurrent remote access using both the connection on the adapter and the onboard RJ45 remote management port provided by the server. The adapter and onboard port have separate IP addresses.

Configuration rules:

- The Redundant System Management Port Adapter is installed in the OCP adapter slot at the rear of the server and is mutually exclusive with any OCP network adapter.

- It is not supported installed in the front OCP slot (if the front OCP slot is configured)
- If the Redundant System Management Port Adapter is installed in the rear slot, then the front OCP slot (if configured) cannot be used.

The following figure shows the server with the Redundant System Management Port Adapter installed in the OCP slot.

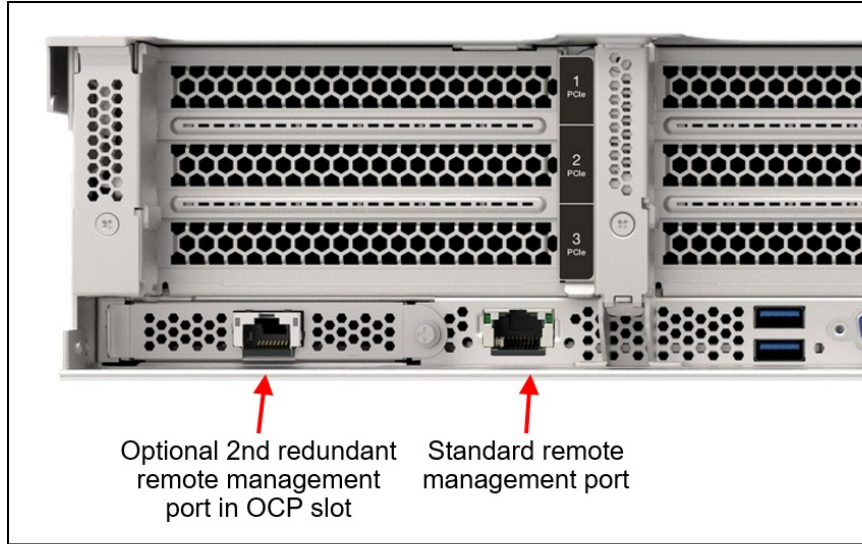

Figure 23. SR665 V3 with the Redundant System Management Port Adapter installed

IPMI via the Ethernet port (IPMI over LAN) is supported, however it is disabled by default. For CTO orders you can specify whether you want to the feature enabled or disabled in the factory, using the feature codes listed in the following table.

Table 79. IPMI-over-LAN settings

Feature code	Description
B7XZ	Disable IPMI-over-LAN (default)
B7Y0	Enable IPMI-over-LAN

XCC2 Platinum

The XCC2 service processor in the SR665 V3 supports an upgrade to the Platinum level of features. Compared to the XCC functions of ThinkSystem V2 and earlier systems, Platinum adds the same features as Enterprise and Advanced levels in ThinkSystem V2, plus additional features.

XCC2 Platinum adds the following Enterprise and Advanced functions:

- Remotely viewing video with graphics resolutions up to 1600x1200 at 75 Hz with up to 23 bits per pixel, regardless of the system state
- Remotely accessing the server using the keyboard and mouse from a remote client
- International keyboard mapping support
- Syslog alerting
- Redirecting serial console via SSH
- Component replacement log (Maintenance History log)
- Access restriction (IP address blocking)
- Lenovo SED security key management
- Displaying graphics for real-time and historical power usage data and temperature
- Boot video capture and crash video capture

- Virtual console collaboration - Ability for up to 6 remote users to be log into the remote session simultaneously
- Remote console Java client
- Mapping the ISO and image files located on the local client as virtual drives for use by the server
- Mounting the remote ISO and image files via HTTPS, SFTP, CIFS, and NFS
- Power capping
- System utilization data and graphic view
- Single sign on with Lenovo XClarity Administrator
- Update firmware from a repository
- License for XClarity Energy Manager

XCC2 Platinum also adds the following features that are new to XCC2:

- System Guard - Monitor hardware inventory for unexpected component changes, and simply log the event or prevent booting
- Enterprise Strict Security mode - Enforces CNSA 1.0 level security
- Neighbor Group - Enables administrators to manage and synchronize configurations and firmware level across multiple servers

Ordering information is listed in the following table. XCC2 Platinum is a software license upgrade - no additional hardware is required.

Table 80. XCC2 Platinum license upgrade

Part number	Feature code	Description
7S0X000KWW	SBCV	Lenovo XClarity Controller 2 (XCC2) Platinum Upgrade

With XCC2 Platinum, for CTO orders, you can request that System Guard be enabled in the factory and the first configuration snapshot be recorded. To add this to an order, select feature code listed in the following table. The selection is made in the Security tab of the DCSC configurator.

Table 81. Enable System Guard in the factory (CTO orders)

Feature code	Description
BUT2	Install System Guard

For more information about System Guard, see https://pubs.lenovo.com/xcc2/NN1ia_c_systemguard

Lenovo XClarity Provisioning Manager

Lenovo XClarity Provisioning Manager (LXPM) is a UEFI-based application embedded in ThinkSystem servers and accessible via the F1 key during system boot.

LXPM provides the following functions:

- Graphical UEFI Setup
- System inventory information and VPD update
- System firmware updates (UEFI and XCC)
- RAID setup wizard
- OS installation wizard (including unattended OS installation)
- Diagnostics functions

Lenovo XClarity Administrator

Lenovo XClarity Administrator is a centralized resource management solution designed to reduce complexity, speed response, and enhance the availability of Lenovo systems and solutions. It provides agent-free hardware management for ThinkSystem servers, in addition to ThinkServer, System x, and Flex System servers. The administration dashboard is based on HTML 5 and allows fast location of resources so tasks can be run quickly.

Because Lenovo XClarity Administrator does not require any agent software to be installed on the managed endpoints, there are no CPU cycles spent on agent execution, and no memory is used, which means that up to 1GB of RAM and 1 - 2% CPU usage is saved, compared to a typical managed system where an agent is required.

Lenovo XClarity Administrator is an optional software component for the SR665 V3. The software can be downloaded and used at no charge to discover and monitor the SR665 V3 and to manage firmware upgrades.

If software support is required for Lenovo XClarity Administrator, or premium features such as configuration management and operating system deployment are required, Lenovo XClarity Pro software subscription should be ordered. Lenovo XClarity Pro is licensed on a per managed system basis, that is, each managed Lenovo system requires a license.

The following table lists the Lenovo XClarity software license options.

Table 82. Lenovo XClarity Pro ordering information

Part number	Feature code	Description
00MT201	1339	Lenovo XClarity Pro, per Managed Endpoint w/1 Yr SW S&S
00MT202	1340	Lenovo XClarity Pro, per Managed Endpoint w/3 Yr SW S&S
00MT203	1341	Lenovo XClarity Pro, per Managed Endpoint w/5 Yr SW S&S
7S0X000HWW	SAYV	Lenovo XClarity Pro, per Managed Endpoint w/6 Yr SW S&S
7S0X000JWW	SAYW	Lenovo XClarity Pro, per Managed Endpoint w/7 Yr SW S&S

Lenovo XClarity Administrator offers the following standard features that are available at no charge:

- Auto-discovery and monitoring of Lenovo systems
- Firmware updates and compliance enforcement
- External alerts and notifications via SNMP traps, syslog remote logging, and e-mail
- Secure connections to managed endpoints
- NIST 800-131A or FIPS 140-2 compliant cryptographic standards between the management solution and managed endpoints
- Integration into existing higher-level management systems such as cloud automation and orchestration tools through REST APIs, providing extensive external visibility and control over hardware resources
- An intuitive, easy-to-use GUI
- Scripting with Windows PowerShell, providing command-line visibility and control over hardware resources

Lenovo XClarity Administrator offers the following premium features that require an optional Pro license:

- Pattern-based configuration management that allows to define configurations once and apply repeatedly without errors when deploying new servers or redeploying existing servers without disrupting the fabric
- Bare-metal deployment of operating systems and hypervisors to streamline infrastructure provisioning

For more information, refer to the Lenovo XClarity Administrator Product Guide:
<http://lenovopress.com/tips1200>

Lenovo XClarity Integrators

Lenovo also offers software plug-in modules, Lenovo XClarity Integrators, to manage physical infrastructure from leading external virtualization management software tools including those from Microsoft and VMware.

These integrators are offered at no charge, however if software support is required, a Lenovo XClarity Pro software subscription license should be ordered.

Lenovo XClarity Integrators offer the following additional features:

- Ability to discover, manage, and monitor Lenovo server hardware from VMware vCenter or Microsoft System Center
- Deployment of firmware updates and configuration patterns to Lenovo x86 rack servers and Flex System from the virtualization management tool
- Non-disruptive server maintenance in clustered environments that reduces workload downtime by dynamically migrating workloads from affected hosts during rolling server updates or reboots
- Greater service level uptime and assurance in clustered environments during unplanned hardware events by dynamically triggering workload migration from impacted hosts when impending hardware failures are predicted

For more information about all the available Lenovo XClarity Integrators, see the Lenovo XClarity Administrator Product Guide: <https://lenovopress.com/tips1200-lenovo-xclarity-administrator>

Lenovo XClarity Essentials

Lenovo offers the following XClarity Essentials software tools that can help you set up, use, and maintain the server at no additional cost:

- **Lenovo Essentials OneCLI**
OneCLI is a collection of server management tools that uses a command line interface program to manage firmware, hardware, and operating systems. It provides functions to collect full system health information (including health status), configure system settings, and update system firmware and drivers.
- **Lenovo Essentials UpdateXpress**
The UpdateXpress tool is a standalone GUI application for firmware and device driver updates that enables you to maintain your server firmware and device drivers up-to-date and help you avoid unnecessary server outages. The tool acquires and deploys individual updates and UpdateXpress System Packs (UXSPs) which are integration-tested bundles.
- **Lenovo Essentials Bootable Media Creator**
The Bootable Media Creator (BOMC) tool is used to create bootable media for offline firmware update.

For more information and downloads, visit the Lenovo XClarity Essentials web page:
<http://support.lenovo.com/us/en/documents/LNVO-center>

Lenovo XClarity Energy Manager

Lenovo XClarity Energy Manager (LXEM) is a power and temperature management solution for data centers. It is an agent-free, web-based console that enables you to monitor and manage power consumption and temperature in your data center through the management console. It enables server density and data center capacity to be increased through the use of power capping.

LXEM is a licensed product. A single-node LXEM license is included with the XClarity Controller Platinum upgrade as described in the [Remote Management](#) section. If your server does not have the XCC Platinum upgrade, Energy Manager licenses can be ordered as shown in the following table.

Table 83. Lenovo XClarity Energy Manager

Part number	Description
4L40E51621	Lenovo XClarity Energy Manager Node License (1 license needed per server)

Note: The SR665 V3 does not support the following Energy Manager functions:

- Power capping
- Policy-based management

For more information about XClarity Energy Manager, see the following resources:

- Lenovo Support page:
<https://datacentersupport.lenovo.com/us/en/solutions/Invo-lxem>
- Lenovo Information Center:
https://sysmgmt.lenovofiles.com/help/topic/LXEM/lxem_overview.html?cp=4

Lenovo Capacity Planner

Lenovo Capacity Planner is a power consumption evaluation tool that enhances data center planning by enabling IT administrators and pre-sales professionals to understand various power characteristics of racks, servers, and other devices. Capacity Planner can dynamically calculate the power consumption, current, British Thermal Unit (BTU), and volt-ampere (VA) rating at the rack level, improving the planning efficiency for large scale deployments.

For more information, refer to the Capacity Planner web page:

<http://datacentersupport.lenovo.com/us/en/solutions/Invo-lcp>

Security

Topics in this section:

- [Security features](#)
- [Platform Firmware Resiliency - Lenovo ThinkShield](#)
- [Security standards](#)

Security features

The SR665 V3 server offers the following electronic security features:

- Secure Boot function of the AMD EPYC processor
- Support for Platform Firmware Resiliency (PFR) hardware Root of Trust (RoT) - see the [Platform Firmware Resiliency](#) section
- Firmware signature processes compliant with FIPS and NIST requirements
- System Guard (part of [XCC Platinum](#)) - Proactive monitoring of hardware inventory for unexpected component changes
- Administrator and power-on password
- Integrated Trusted Platform Module (TPM) supporting TPM 2.0
- Self-encrypting drives (SEDs) with support for enterprise key managers - see the [SED encryption key management](#) section

The server is NIST SP 800-147B compliant.

The SR665 V3 server also offers the following physical security features:

- Optional chassis intrusion switch
- Optional lockable front security bezel

The optional lockable front security bezel is shown in the following figure and includes a key that enables you to secure the bezel over the drives and system controls thereby reducing the chance of unauthorized or accidental access to the server.

Front PCIe slots: The use of the security bezel is not supported when the server has front PCIe slots.



Figure 24. Lockable front security bezel

The dimensions of the security bezel are:

- Width: 437 mm (17.2 in.)
- Height: 87 mm (3.4 in.)
- Width: 23 mm (0.9 in.)

The following table lists the security options for the SR665 V3.

Table 84. Security features

Part number	Feature code	Description
4X97A90518	BVGB	ThinkSystem SR665 V3 Intrusion Cable
4XH7A09886	B8M2	ThinkSystem V2 2U Security Bezel Option Kit
4XH7A90300	BXBQ	ThinkSystem V3 2U Security Bezel Option Kit

Tip: The only difference between security bezels 4XH7A09886 and 4XH7A90300 is the Lenovo logo: On 4XH7A09886, the logo is made from plastic; on 4XH7A90300, the logo is made from aluminum alloy.

Platform Firmware Resiliency - Lenovo ThinkShield

Lenovo's ThinkShield Security is a transparent and comprehensive approach to security that extends to all dimensions of our data center products: from development, to supply chain, and through the entire product lifecycle.

The ThinkSystem SR665 V3 includes Platform Firmware Resiliency (PFR) hardware Root of Trust (RoT) which enables the system to be NIST SP800-193 compliant. This offering further enhances key platform subsystem protections against unauthorized firmware updates and corruption, to restore firmware to an integral state, and to closely monitor firmware for possible compromise from cyber attacks.

PFR operates upon the following server components:

- UEFI image – the low-level server firmware that connects the operating system to the server hardware
- XCC image – the management “engine” software that controls and reports on the server status separate from the server operating system

- FPGA image – the code that runs the server’s lowest level hardware controller on the motherboard

The Lenovo Platform Root of Trust Hardware performs the following three main functions:

- Detection – Measures the firmware and updates for authenticity
- Recovery – Recovers a corrupted image to a known-safe image
- Protection – Monitors the system to ensure the known-good firmware is not maliciously written

These enhanced protection capabilities are implemented using a dedicated, discrete security processor whose implementation has been rigorously validated by leading third-party security firms. Security evaluation results and design details are available for customer review – providing unprecedented transparency and assurance.

The SR665 V3 includes support for Secure Boot, a UEFI firmware security feature developed by the UEFI Consortium that ensures only immutable and signed software are loaded during the boot time. The use of Secure Boot helps prevent malicious code from being loaded and helps prevent attacks, such as the installation of rootkits. Lenovo offers the capability to enable secure boot in the factory, to ensure end-to-end protection. Alternatively, Secure Boot can be left disabled in the factory, allowing the customer to enable it themselves at a later point, if desired.

The following table lists the relevant feature code(s).

Table 85. Secure Boot options

Part number	Feature code	Description	Purpose
CTO only	BPKQ	TPM 2.0 with Secure Boot	Configure the system in the factory with Secure Boot enabled.
CTO only	BPKR	TPM 2.0	Configure the system without Secure Boot enabled. Customers can enable Secure Boot later if desired.

Tip: If Secure Boot is not enabled in the factory, it can be enabled later by the customer. However once Secure Boot is enabled, it cannot be disabled.

Security standards

The SR665 V3 supports the following security standards and capabilities:

- **Industry Standard Security Capabilities**
 - AMD CPU Enablement
 - AES-NI (Advanced Encryption Standard New Instructions)
 - GMET (Guest Mode Execute Trap)
 - Hardware-based side channel attack resilience enhancements
 - NX (No eXecute)
 - PSB (Platform Secure Boot)
 - Shadow Stack
 - SEV (Secure Encrypted Virtualization)
 - SEV-ES (Encrypted State register encryption)
 - SEV-SNP (Secure Nested Paging)
 - SVM (Secure Virtual Machine)
 - SME (Secure Memory Encryption)
 - UMIP (User Mode Instruction Prevention)
 - Microsoft Windows Security Enablement
 - Credential Guard
 - Device Guard
 - Host Guardian Service

- TCG (Trusted Computing Group) TPM (Trusted Platform Module) 2.0
- UEFI (Unified Extensible Firmware Interface) Forum Secure Boot
- **Hardware Root of Trust and Security**
 - Independent security subsystem providing platform-wide NIST SP800-193 compliant Platform Firmware Resilience (PFR)
 - Host domain RoT supplemented by AMD Platform Secure Boot (PSB)
 - Management domain RoT supplemented by the Secure Boot features of XCC
- **Platform Security**

For more information on platform security, see the paper “How to Harden the Security of your ThinkSystem Server and Management Applications” available from <https://lenovopress.com/lp1260-how-to-harden-the-security-of-your-thinksystem-server>.

 - Boot and run-time firmware integrity monitoring with rollback to known-good firmware (e.g., “self-healing”)
 - Non-volatile storage bus security monitoring and filtering
 - Resilient firmware implementation, such as to detect and defeat unauthorized flash writes or SMM (System Management Mode) memory incursions
 - Patented IPMI KCS channel privileged access authorization (USPTO Patent# 11,256,810)
 - Host and management domain authorization, including integration with CyberArk for enterprise password management
 - KMIP (Key Management Interoperability Protocol) compliant, including support for IBM SKLM and Thales KeySecure
 - Reduced “out of box” attack surface
 - Configurable network services
 - FIPS 140-3 (in progress) validated cryptography for XCC
 - CNSA Suite 1.0 Quantum-resistant cryptography for XCC
 - Lenovo System Guard
- **Standards Compliance and/or Support**
 - NIST SP800-131A rev 2 “Transitioning the Use of Cryptographic Algorithms and Key Lengths”
 - NIST SP800-147B “BIOS Protection Guidelines for Servers”
 - NIST SP800-193 “Platform Firmware Resiliency Guidelines”
 - ISO/IEC 11889 “Trusted Platform Module Library”
 - Common Criteria TCG Protection Profile for “PC Client Specific TPM 2.0”
 - European Union Commission Regulation 2019/424 (“ErP Lot 9”) “Ecodesign Requirements for Servers and Data Storage Products” Secure Data Deletion
 - Optional FIPS 140-2 validated Self-Encrypting Disks (SEDs) with external KMIP-based key management
- **Product and Supply Chain Security**
 - Suppliers validated through Lenovo’s Trusted Supplier Program
 - Developed in accordance with Lenovo’s Secure Development Lifecycle (LSDL)
 - Continuous firmware security validation through automated testing, including static code analysis, dynamic network and web vulnerability testing, software composition analysis, and subsystem-specific testing, such as UEFI security configuration validation
 - Ongoing security reviews by US-based security experts, with attestation letters available from our third-party security partners

- Digitally signed firmware, stored and built on US-based infrastructure and signed on US-based Hardware Security Modules (HSMs)
- Manufacturing transparency via Intel Transparent Supply Chain (for details, see <https://lenovopress.com/lp1434-introduction-to-intel-transparent-supply-chain-on-lenovo-thinksystem-servers>)
- TAA (Trade Agreements Act) compliant manufacturing, by default in Mexico for North American markets with additional US and EU manufacturing options
- US 2019 NDAA (National Defense Authorization Act) Section 889 compliant

Rack installation

The following table lists the rack installation options that are available for the SR665 V3.

Table 86. Rack installation options

Part number	Feature	Description
Rail Kits		
4M17A13564	BK7W	ThinkSystem Toolless Friction Rail v2
4M17A11754	B8LA	ThinkSystem Toolless Slide Rail Kit v2
4M17A11756	B91Y	ThinkSystem Toolless Slide Rail Kit v2 with 2U CMA
Enhanced Rail Kits for > 34 kg server weight*		
4M17A11755	B8LB	ThinkSystem Toolless Slide Rail Kit v2 Enhanced
4M17A11757	B97N	ThinkSystem Toolless Slide Rail Kit v2 Enhanced with 2U CMA
Separate Cable Management Arm		
7M27A05698	B135	ThinkSystem 2U CMA Upgrade Kit for Toolless Slide Rail

* The Enhanced Slide Rail Kits are used when the server is shipped in a rack and the server is 34 kg or heavier (configuration with 20x 3.5-inch HDDs for example)

The following table summarizes the rail kit features and specifications.

Table 87. Rail kit features and specifications summary

Feature	ThinkSystem Toolless Friction Rail v2	ThinkSystem Toolless Slide Rail Kit v2	ThinkSystem Toolless Slide Rail Kit v2 Enhanced	ThinkSystem Toolless Slide Rail Kit v2 with 2U CMA	ThinkSystem Toolless Slide Rail Kit v2 Enhanced with 2U CMA
Option part number	4M17A13564	4M17A11754	4M17A11755	4M17A11756	4M17A11757
Rail type	Half-out slide rail (friction)	Full-out slide rail (ball bearing)	Full-out slide rail (ball bearing)	Full-out slide rail (ball bearing)	Full-out slide rail (ball bearing)
Toolless installation	Yes	Yes	Yes	Yes	Yes
CMA support	No	Optional, 7M27A05698*	Optional, 7M27A05698*	Included	Included
Supported rack type	Four-post IBM and Lenovo standard rack, complying with the IEC standard	Four-post IBM and Lenovo standard rack, complying with the IEC standard	Four-post IBM and Lenovo standard rack, complying with the IEC standard	Four-post IBM and Lenovo standard rack, complying with the IEC standard	Four-post IBM and Lenovo standard rack, complying with the IEC standard
In-rack server maintenance	No	Yes	Yes	Yes	Yes
1U PDU support	Yes	Yes	Yes	Yes	Yes
0U PDU support	Yes	Limited support**	Limited support**	Limited support**	Limited support**
Supported mounting holes	Square or round	Square or round	Square, round, or threaded	Square or round	Square, round, or threaded
Thickness of mounting flanges	2.0-3.3 mm (0.08-0.13 inches)	2.0-3.3 mm (0.08-0.13 inches)	2.0-3.3 mm (0.08-0.13 inches)	2.0-3.3 mm (0.08-0.13 inches)	2.0-3.3 mm (0.08-0.13 inches)
Supported distance between front and rear mounting flanges‡	610-864 mm (24-34 inches)	610-813 mm (24-32 inches)	635-813 mm (25-32 inches)	610-813 mm (24-32 inches)	635-813 mm (25-32 inches)
Rail length†	751 mm (29.6 inches)	740 mm (29.1 inches)	740 mm (29.1 inches)	820 mm (32.3 inches)	820 mm (32.3 inches)

* CMA mounting brackets are not preinstalled on the rail. The CMA mounting brackets are contained in the CMA option kit package and you will need to install the CMA mounting brackets first. For detailed instructions, refer to the documentation that comes with the CMA option kit.

** If you want to install the rails and a 0U PDU into the same rack, the rack must meet the height and depth requirements as described in [ThinkSystem Rail Support Matrix](#).

‡ For best performance, it is recommended that you install the rails to the racks with a 719-mm distance (28.31-inch, Lenovo rack default distance) between the front and rear mounting flanges.

† Measured when mounted on the rack, from the front surface of the front mounting flange to the rear most point of the rail. Rail is in closed position.

Operating system support

The SR665 V3 supports the following operating systems:

- Microsoft Windows 10 Professional (x64)
- Microsoft Windows 11 Professional (x64)
- Microsoft Windows Server 2019
- Microsoft Windows Server 2022
- Red Hat Enterprise Linux 8.6
- Red Hat Enterprise Linux 8.7
- Red Hat Enterprise Linux 8.8
- Red Hat Enterprise Linux 8.9
- Red Hat Enterprise Linux 9.0
- Red Hat Enterprise Linux 9.1
- Red Hat Enterprise Linux 9.2
- Red Hat Enterprise Linux 9.3
- SUSE Linux Enterprise Server 15 SP4
- SUSE Linux Enterprise Server 15 SP5
- SUSE Linux Enterprise Server 15 Xen SP4
- SUSE Linux Enterprise Server 15 Xen SP5
- Ubuntu 20.04 LTS 64-bit
- Ubuntu 22.04 LTS 64-bit
- VMware ESXi 7.0 U3
- VMware ESXi 8.0
- VMware ESXi 8.0 U1
- VMware ESXi 8.0 U2

For a complete list of supported, certified and tested operating systems, plus additional details and links to relevant web sites, see the Operating System Interoperability Guide:

<https://lenovopress.lenovo.com/osig#servers=sr665-v3-7d9b-7d9a>

For configure-to-order configurations, the server can be preloaded with VMware ESXi installed on M.2 cards. Ordering information is listed in the following table.

Table 88. VMware ESXi preload

Part number	Feature code	Description
CTO only	BMEY	VMware ESXi 7.0 U3 (Factory Installed)
CTO only	BMT5	VMware ESXi 8.0 (Factory Installed)
CTO only	BYC7	VMware ESXi 8.0 U2 (Factory Installed)

You can download supported VMware vSphere hypervisor images from the following web page and load it on the M.2 drives or 7mm drives using the instructions provided:

https://vmware.lenovo.com/content/custom_iso/

Windows 10 and Windows 11

The SR665 V3 can now run Windows 10 and Windows 11, however only a subset of adapters and drives can be installed. For ease of configuration, additional Base CTO models 7D9ACTO2WW and 7D9BCTO2WW have been created to assist building a configuration that can be used with the client operating systems. See the [Models](#) section for details.

The XClarity management toolset is supported with Windows 10 and Windows 11.

Windows client license: A Windows client license for the system cannot be ordered from Lenovo nor can the OS be preloaded on the system in the factory. For the Windows license and for preloads, please contact your Lenovo business partner. A Windows Pro license is required as a qualifying base OS license in order to use a client Volume License offering.

See the part number tables in the following sections to see which adapters are supported with Windows 10 and Windows 11:

- [Controllers for internal storage](#)
- [M.2 adapters](#)
- [Network adapters](#)
- [GPU adapters](#)

GPU recommended: Lenovo recommends that if you plan to install Windows 10 or 11 on this server to run graphics-intensive applications, then you should selected a dedicated graphics adapter (GPU).

The following components are not supported:

- Fibre Channel adapters
- InfiniBand and VPI adapters
- External storage adapters
- Flash storage adapters

Physical and electrical specifications

The SR665 V3 has the following overall physical dimensions, excluding components that extend outside the standard chassis, such as EIA flanges, front security bezel (if any), and power supply handles:

- Width: 445 mm (17.5 inches)
- Height: 87 mm (3.4 inches)
- Depth: 766 mm (30.1 inches)

The following table lists the detailed dimensions. See the figure below for the definition of each dimension.

Table 89. Detailed dimensions

Dimension	Description
482 mm	X_a = Width, to the outsides of the front EIA flanges
435 mm	X_b = Width, to the rack rail mating surfaces
445 mm	X_c = Width, to the outer most chassis body feature
87 mm	Y_a = Height, from the bottom of chassis to the top of the chassis
698 mm	Z_a = Depth, from the rack flange mating surface to the rearmost I/O port surface
732 mm	Z_b = Depth, from the rack flange mating surface to the rearmost feature of the chassis body
727 mm (≤1100W) 755 mm (1800W) 781 mm (2400W)	Z_c = Depth, from the rack flange mating surface to the rearmost feature such as power supply handle
34 mm	Z_d = Depth, from the forwardmost feature on front of EIA flange to the rack flange mating surface
46 mm	Z_e = Depth, from the front of security bezel (if applicable) or forwardmost feature to the rack flange mating surface

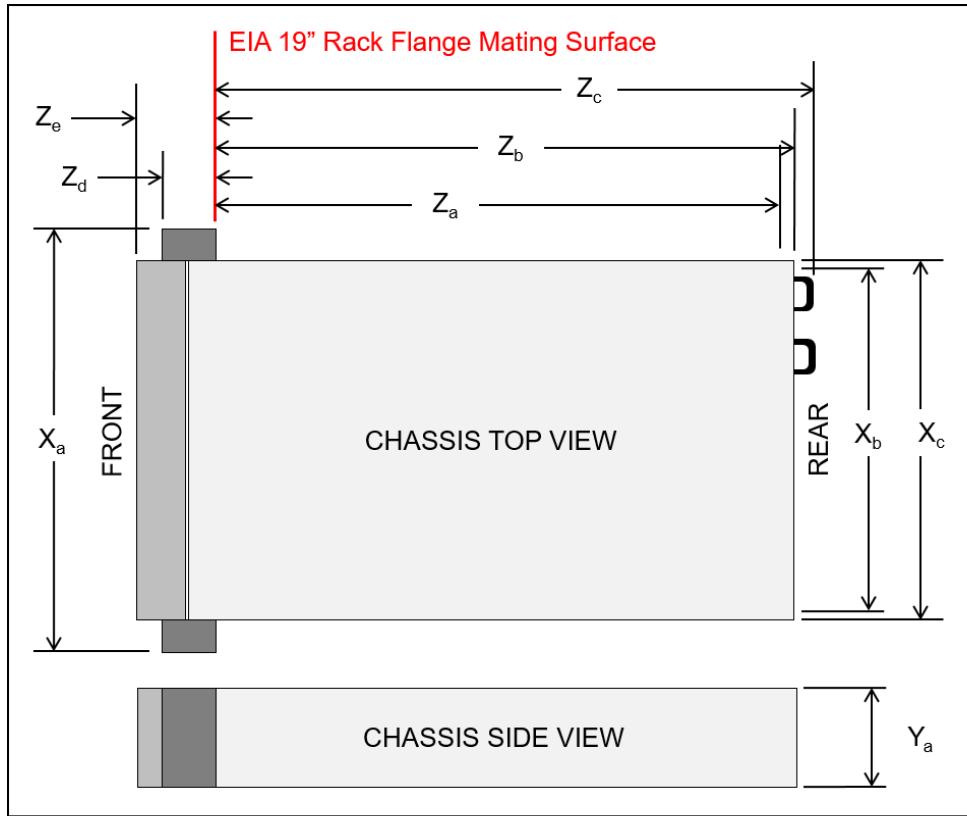

Figure 25. Server dimensions

The shipping dimensions (cardboard packaging) of the SR665 V3 are as follows:

- Width: 592 mm (23.3 inches)
- Height: 282 mm (11.1 inches)
- Depth: 992 mm (39.1 inches)

The server has the following weight:

- Maximum weight: 38.8 kg (85.5 lb)

Electrical specifications for AC input power supplies:

- Input voltage:
 - 100 to 127 (nominal) Vac, 50 Hz or 60 Hz
 - 200 to 240 (nominal) Vac, 50 Hz or 60 Hz
 - 180 to 300 Vdc (China only)
- Inlet current: See the following table.

Table 90. Maximum inlet current

Part number	Description	100V AC	200V AC	220V AC	240V DC
AC input power - 80 PLUS Titanium efficiency					
4P57A82019	ThinkSystem 750W 230V Titanium Hot-Swap Gen2 Power Supply v3	No support	4A	3.6A	3.3A
4P57A72666	ThinkSystem 1100W 230V Titanium Hot-Swap Gen2 Power Supply	No support	5.9A	5.3A	5A
4P57A78359	ThinkSystem 1800W 230V Titanium Hot-Swap Gen2 Power Supply	No support	9.7A	8.7A	8.3A
4P57A72667	ThinkSystem 2600W 230V Titanium Hot-Swap Gen2 Power Supply	No support	13.2A	13A	11.9A
AC input power - 80 PLUS Platinum efficiency					
4P57A72670	ThinkSystem 750W 230V/115V Platinum Hot-Swap Gen2 Power Supply v3	8.4A	4.1A	3.69A	3.5A
4P57A72671	ThinkSystem 1100W 230V/115V Platinum Hot-Swap Gen2 Power Supply v3	12A	6A	5.4A	5.1A
4P57A26294	ThinkSystem 1800W 230V Platinum Hot-Swap Gen2 Power Supply v2	No support	10A	9.1A	9A
4P57A26295	ThinkSystem 2400W 230V Platinum Hot-Swap Gen2 Power Supply	No support	14A	12.6A	12A

Electrical specifications for DC input power supply:

- Input voltage: -48 to -60 Vdc
- Inlet current (1100W power supply): 26 A

Operating environment

The SR665 V3 server complies with ASHRAE Class A2 specifications with most configurations, and depending on the hardware configuration, also complies with ASHRAE Class A3 and Class A4 specifications. System performance may be impacted when operating temperature is outside ASHRAE A2 specification.

Depending on the hardware configuration, the SR665 V3 server also complies with ASHRAE Class H1 specification. System performance may be impacted when operating temperature is outside ASHRAE H1 specification.

Topics in this section:

- [Ambient temperature requirements](#)
- [Temperature and humidity](#)
- [Acoustical noise emissions](#)
- [Shock and vibration](#)
- [Particulate contamination](#)

Ambient temperature requirements

Additional restrictions to ASHRAE support, based on server configuration, are as follows:

- The ambient temperature must be limited to 35°C or lower if the server has any of the following components:
 - Broadcom 57416 10GBASE-T 2-port OCP

- Broadcom 57454 10GBASE-T 4-port OCP
 - PCIe network adapters at a rate greater than or equal to 100 Gb
 - Network adapters with AOC and at the rate of 25 GB
- The ambient temperature must be limited to 30°C or lower if the server has any of the following components:
 - 24 x 2.5" or 12 x 3.5" front bay, middle bay, or rear bay
 - GPU adapters
 - Network adapters with AOC and at a rate greater than 25 Gb
 - The ambient temperature must be limited to 25°C or lower if the server has processor 320 W ≤ TDP ≤ 400 W

Server shutdown: When the ambient temperature is greater than the supported max temperature (ASHRAE A4 45°C), the server will shut down. The server will not power on again until the ambient temperature falls within the supported temperature range.

For additional information, see the Environmental specifications and Thermal rules sections in the product documentation:

https://pubs.lenovo.com/sr665-v3/server_specifications_environmental

https://pubs.lenovo.com/sr665-v3/thermal_rules

Temperature and humidity

The server is supported in the following environment:

- Air temperature:
 - Operating:
 - ASHRAE Class A2: 10°C to 35°C (50°F to 95°F); the maximum ambient temperature decreases by 1°C for every 300 m (984 ft) increase in altitude above 900 m (2,953 ft).
 - ASHRAE Class A3: 5°C to 40°C (41°F to 104°F); the maximum ambient temperature decreases by 1°C for every 175 m (574 ft) increase in altitude above 900 m (2,953 ft).
 - ASHRAE Class A4: 5°C to 45°C (41°F to 113°F); the maximum ambient temperature decreases by 1°C for every 125 m (410 ft) increase in altitude above 900 m (2,953 ft).
 - ASHRAE Class H1: 5 °C to 25 °C (41 °F to 77 °F); Decrease the maximum ambient temperature by 1°C for every 500 m (1640 ft) increase in altitude above 900 m (2,953 ft).
 - Server off: 5°C to 45°C (41°F to 113°F)
 - Shipment/storage: -40°C to 60°C (-40°F to 140°F)
- Maximum altitude: 3,050 m (10,000 ft)
- Relative Humidity (non-condensing):
 - Operating
 - ASHRAE Class A2: 8% to 80%; maximum dew point: 21°C (70°F)
 - ASHRAE Class A3: 8% to 85%; maximum dew point: 24°C (75°F)
 - ASHRAE Class A4: 8% to 90%; maximum dew point: 24°C (75°F)
 - ASHRAE Class H1: 8% to 80%; Maximum dew point: 17°C (63°F)
 - Shipment/storage: 8% to 90%

Acoustical noise emissions

The server has the following acoustic noise emissions declaration:

- Sound power level (L_{WAd}):
 - Idling: 5.9 Bel (Min), 6.5 Bel (Typical), 7.3 Bel (GPU rich), 7.3 Bel (Storage rich)
 - Operating: 6.5 Bel (Min), 8.1 Bel (Typical), 8.7 Bel (GPU rich), 7.5 Bel (Storage rich)
- Sound pressure level (L_{pAm}):
 - Idling: 41.5 dBA (Min), 51 dBA (Typical), 60.2 dBA (GPU rich), 60.2 dBA (Storage rich)
 - Operating: 48.3 dBA (Min), 66.6 dBA (Typical), 71.9 dBA (GPU rich), 61.3 dBA (Storage rich)

Notes:

- These sound levels were measured in controlled acoustical environments according to procedures specified by ISO7779 and are reported in accordance with ISO 9296.
- The declared acoustic sound levels are based on the following configurations, which may change depending on configuration/conditions :
 - Min: 2x 240W CPU, 12x 64GB RDIMMs, 8x SAS HDDs, RAID 940-8i, Intel E810-DA2 10/25GbE SFP28 2-Port OCP, 2x 1100W PSU
 - Typical: 2x 300W CPU, 24x 64GB RDIMMs, 16x SAS HDDs, RAID 940-8i, Intel E810-DA2 10/25GbE SFP28 2-Port OCP, 2x 1800W PSU
 - GPU rich: 2x 300W CPU, 24x 64GB RDIMMs, 16x SAS HDDs, RAID 940-16i, Intel E810-DA2 10/25GbE SFP28 2-Port OCP, 3x A100 80G GPUs, 2x 2400W PSU
 - Storage rich: 2x 240W CPU, 12x 64GB RDIMMs, 16x SAS HDDs, RAID 940-8i, Intel E810-DA2 10/25GbE SFP28 2-Port OCP, 2x 1800W PSU
- Government regulations (such as those prescribed by OSHA or European Community Directives) may govern noise level exposure in the workplace and may apply to you and your server installation. The actual sound pressure levels in your installation depend upon a variety of factors, including the number of racks in the installation; the size, materials, and configuration of the room; the noise levels from other equipment; the room ambient temperature, and employee's location in relation to the equipment. Further, compliance with such government regulations depends on a variety of additional factors, including the duration of employees' exposure and whether employees wear hearing protection. Lenovo recommends that you consult with qualified experts in this field to determine whether you are in compliance with the applicable regulations.

Shock and vibration

The server has the following vibration and shock limits:

- Vibration:
 - Operating: 0.21 G rms at 5 Hz to 500 Hz for 15 minutes across 3 axes
 - Non-operating: 1.04 G rms at 2 Hz to 200 Hz for 15 minutes across 6 surfaces
- Shock:
 - Operating: 15 G for 3 milliseconds in each direction (positive and negative X, Y, and Z axes)
 - Non-operating:
 - 23 kg - 31 kg: 35 G for 152 in./sec velocity change across 6 surfaces (3x GPU config, 2.5" config)
 - 32 kg - 68 kg: 35 G for 136 in./sec velocity change across 6 surfaces (20x 3.5" HDD config)

Particulate contamination

Airborne particulates (including metal flakes or particles) and reactive gases acting alone or in combination with other environmental factors such as humidity or temperature might damage the system that might cause the system to malfunction or stop working altogether.

The following specifications indicate the limits of particulates that the system can tolerate:

- Reactive gases:
 - The copper reactivity level shall be less than 200 Angstroms per month (Å/month)
 - The silver reactivity level shall be less than 200 Å/month
- Airborne particulates:
 - The room air should be continuously filtered with MERV 8 filters.
 - Air entering a data center should be filtered with MERV 11 or preferably MERV 13 filters.
 - The deliquescent relative humidity of the particulate contamination should be more than 60% RH
 - Environment must be free of zinc whiskers

For additional information, see the Specifications section of the documentation for the server, available from the Lenovo Documents site, <https://pubs.lenovo.com/>

Warranty and Support

The SR665 V3 has a 1-year or 3-year warranty based on the machine type of the system:

- 7D9B - 1 year warranty
- 7D9A - 3 year warranty

The standard warranty terms are customer-replaceable unit (CRU) and onsite (for field-replaceable units FRUs only) with standard call center support during normal business hours and 9x5 Next Business Day Parts Delivered.

Lenovo's additional support services provide a sophisticated, unified support structure for your data center, with an experience consistently ranked number one in customer satisfaction worldwide. Available offerings include:

- **Premier Support**

Premier Support provides a Lenovo-owned customer experience and delivers direct access to technicians skilled in hardware, software, and advanced troubleshooting, in addition to the following:

- Direct technician-to-technician access through a dedicated phone line
- 24x7x365 remote support
- Single point of contact service
- End to end case management
- Third-party collaborative software support
- Online case tools and live chat support
- On-demand remote system analysis

- **Warranty Upgrade (Preconfigured Support)**

Services are available to meet the on-site response time targets that match the criticality of your systems.

- 3, 4, or 5 years of service coverage
- 1-year or 2-year post-warranty extensions
- **Foundation Service:** 9x5 service coverage with next business day onsite response. YourDrive YourData is an optional extra (see below).
- **Essential Service:** 24x7 service coverage with 4-hour onsite response or 24-hour committed repair (available only in select markets). Bundled with YourDrive YourData.
- **Advanced Service:** 24x7 service coverage with 2-hour onsite response or 6-hour committed repair (available only in select markets). Bundled with YourDrive YourData.

- **Managed Services**

Lenovo Managed Services provides continuous 24x7 remote monitoring (plus 24x7 call center availability) and proactive management of your data center using state-of-the-art tools, systems, and practices by a team of highly skilled and experienced Lenovo services professionals.

Quarterly reviews check error logs, verify firmware & OS device driver levels, and software as needed. We'll also maintain records of latest patches, critical updates, and firmware levels, to ensure you systems are providing business value through optimized performance.

- **Technical Account Management (TAM)**

A Lenovo Technical Account Manager helps you optimize the operation of your data center based on a deep understanding of your business. You gain direct access to your Lenovo TAM, who serves as your single point of contact to expedite service requests, provide status updates, and furnish reports to track incidents over time. In addition, your TAM will help proactively make service recommendations and manage your service relationship with Lenovo to make certain your needs are met.

- **Enterprise Server Software Support**

Enterprise Software Support is an additional support service providing customers with software support on Microsoft, Red Hat, SUSE, and VMware applications and systems. Around the clock availability for critical problems plus unlimited calls and incidents helps customers address challenges fast, without incremental costs. Support staff can answer troubleshooting and diagnostic questions, address product comparability and interoperability issues, isolate causes of problems, report defects to software vendors, and more.

- **YourDrive YourData**

Lenovo's YourDrive YourData is a multi-drive retention offering that ensures your data is always under your control, regardless of the number of drives that are installed in your Lenovo server. In the unlikely event of a drive failure, you retain possession of your drive while Lenovo replaces the failed drive part. Your data stays safely on your premises, in your hands. The YourDrive YourData service can be purchased in convenient bundles and is optional with Foundation Service. It is bundled with Essential Service and Advanced Service.

- **Health Check**

Having a trusted partner who can perform regular and detailed health checks is central to maintaining efficiency and ensuring that your systems and business are always running at their best. Health Check supports Lenovo-branded server, storage, and networking devices, as well as select Lenovo-supported products from other vendors that are sold by Lenovo or a Lenovo-Authorized Reseller.

Examples of region-specific warranty terms are second or longer business day parts delivery or parts-only base warranty.

If warranty terms and conditions include onsite labor for repair or replacement of parts, Lenovo will dispatch a service technician to the customer site to perform the replacement. Onsite labor under base warranty is limited to labor for replacement of parts that have been determined to be field-replaceable units (FRUs). Parts that are determined to be customer-replaceable units (CRUs) do not include onsite labor under base warranty.

If warranty terms include parts-only base warranty, Lenovo is responsible for delivering only replacement parts that are under base warranty (including FRUs) that will be sent to a requested location for self-service. Parts-only service does not include a service technician being dispatched onsite. Parts must be changed at customer's own cost and labor and defective parts must be returned following the instructions supplied with the spare parts.

Lenovo Service offerings are region-specific. Not all preconfigured support and upgrade options are available in every region. For information about Lenovo service upgrade offerings that are available in your region, refer to the following resources:

- Service part numbers in Lenovo Data Center Solution Configurator (DCSC):
<http://dcsc.lenovo.com/#/services>
- Lenovo Services Availability Locator
<http://lenovolocator.com/>

For service definitions, region-specific details, and service limitations, please refer to the following documents:

- Lenovo Statement of Limited Warranty for Infrastructure Solutions Group (ISG) Servers and System Storage
<http://pcsupport.lenovo.com/us/en/solutions/ht503310>
- Lenovo Data Center Services Agreement
<http://support.lenovo.com/us/en/solutions/ht116628>

Services

Lenovo Services is a dedicated partner to your success. Our goal is to reduce your capital outlays, mitigate your IT risks, and accelerate your time to productivity.

Note: Some service options may not be available in all markets or regions. For more information, go to <https://www.lenovo.com/services>. For information about Lenovo service upgrade offerings that are available in your region, contact your local Lenovo sales representative or business partner.

Here's a more in-depth look at what we can do for you:

- **Asset Recovery Services**

Asset Recovery Services (ARS) helps customers recover the maximum value from their end-of-life equipment in a cost-effective and secure way. On top of simplifying the transition from old to new equipment, ARS mitigates environmental and data security risks associated with data center equipment disposal. Lenovo ARS is a cash-back solution for equipment based on its remaining market value, yielding maximum value from aging assets and lowering total cost of ownership for your customers. For more information, see the ARS page, <https://lenovopress.com/lp1266-reduce-e-waste-and-grow-your-bottom-line-with-lenovo-ars>.

- **Assessment Services**

An Assessment helps solve your IT challenges through an onsite, multi-day session with a Lenovo technology expert. We perform a tools-based assessment which provides a comprehensive and thorough review of a company's environment and technology systems. In addition to the technology based functional requirements, the consultant also discusses and records the non-functional business requirements, challenges, and constraints. Assessments help organizations like yours, no matter how large or small, get a better return on your IT investment and overcome challenges in the ever-changing technology landscape.

- **Design Services**

Professional Services consultants perform infrastructure design and implementation planning to support your strategy. The high-level architectures provided by the assessment service are turned into low level designs and wiring diagrams, which are reviewed and approved prior to implementation. The implementation plan will demonstrate an outcome-based proposal to provide business capabilities through infrastructure with a risk-mitigated project plan.

- **Basic Hardware Installation**

Lenovo experts can seamlessly manage the physical installation of your server, storage, or networking hardware. Working at a time convenient for you (business hours or off shift), the technician will unpack and inspect the systems on your site, install options, mount in a rack cabinet, connect to power and network, check and update firmware to the latest levels, verify operation, and dispose of the packaging, allowing your team to focus on other priorities.

- **Deployment Services**

When investing in new IT infrastructures, you need to ensure your business will see quick time to value with little to no disruption. Lenovo deployments are designed by development and engineering teams who know our Products & Solutions better than anyone else, and our technicians own the process from delivery to completion. Lenovo will conduct remote preparation and planning, configure & integrate systems, validate systems, verify and update appliance firmware, train on administrative tasks, and provide post-deployment documentation. Customer's IT teams leverage our skills to enable IT staff to transform with higher level roles and tasks.

- **Integration, Migration, and Expansion Services**

Move existing physical & virtual workloads easily, or determine technical requirements to support increased workloads while maximizing performance. Includes tuning, validation, and documenting ongoing run processes. Leverage migration assessment planning documents to perform necessary migrations.

Regulatory compliance

The SR665 V3 conforms to the following standards:

- ANSI/UL 62368-1
- IEC 62368-1 (CB Certificate and CB Test Report)
- FCC - Verified to comply with Part 15 of the FCC Rules, Class A
- Canada ICES-003, issue 7, Class A
- CSA C22.2 No. 62368-1
- CISPR 32, Class A, CISPR 35
- Japan VCCI, Class A
- Taiwan BSMI CNS15936, Class A; CNS15598-1; Section 5 of CNS15663
- CE, UKCA Mark (EN55032 Class A, EN62368-1, EN55024, EN55035, EN61000-3-2, EN61000-3-3, (EU) 2019/424, and EN IEC 63000 (RoHS))
- Korea KN32, Class A, KN35
- Russia, Belorussia and Kazakhstan, TP EAC 037/2016 (for RoHS)
- Russia, Belorussia and Kazakhstan, EAC: TP TC 004/2011 (for Safety); TP TC 020/2011 (for EMC)
- Australia/New Zealand AS/NZS CISPR 32, Class A; AS/NZS 62368.1
- UL Green Guard, UL2819
- Energy Star 3.0
- EPEAT (NSF/ ANSI 426) Bronze
- China CCC certificate, GB17625.1; GB4943.1; GB/T9254
- China CECP certificate, CQC3135
- China CELP certificate, HJ 2507-2011
- Japanese Energy-Saving Act
- Mexico NOM-019
- TUV-GS (EN62368-1, and EK1-ITB2000)
- India BIS 13252 (Part 1)
- Germany GS
- Brazil INMETRO
- Ukraine UkrCEPRO
- Morocco CMIM Certification (CM)

External drive enclosures

The server supports attachment to external drive enclosures using a RAID controller with external ports or a SAS host bus adapter. Adapters supported by the server are listed in the [SAS adapters for external storage](#) section.

Note: Information provided in this section is for ordering reference purposes only. For the operating system and adapter support details, refer to the interoperability matrix for a particular storage enclosure that can be found on the Lenovo Data Center Support web site:

<http://datacentersupport.lenovo.com>

Table 91. External drive enclosures

Model	Description
4587HC1	Lenovo Storage D1212 Disk Expansion Enclosure (2U enclosure wth 12x LFF drive bays)
4587HC2	Lenovo Storage D1224 Disk Expansion Enclosure (2U enclosure wth 24x SFF drive bays)
6413HC1	Lenovo Storage D3284 High Density Expansion Enclosure (5U enclosure wth 84x LFF drive bays)
7DAHCTO1WW	Lenovo ThinkSystem D4390 Direct Attached Storage (4U enclosure wth 90x LFF drive bays)

For details about supported drives, adapters, and cables, see the following Lenovo Press Product Guides:

- Lenovo Storage D1212 and D1224
<http://lenovopress.lenovo.com/lp0512>
- Lenovo Storage D3284
<http://lenovopress.lenovo.com/lp0513>
- Lenovo ThinkSystem D4390
<https://lenovopress.lenovo.com/lp1681>

External storage systems

Lenovo offers the ThinkSystem DE Series and ThinkSystem DM Series external storage systems for high-performance storage. See the DE Series and DM Series product guides for specific controller models, expansion enclosures and configuration options:

- ThinkSystem DE Series Storage
<https://lenovopress.com/storage/thinksystem/de-series#rt=product-guide>
- ThinkSystem DM Series Storage
<https://lenovopress.com/storage/thinksystem/dm-series#rt=product-guide>
- ThinkSystem DG Series Storage
<https://lenovopress.com/storage/thinksystem/dg-series#rt=product-guide>

External backup units

The following table lists the external backup options that are offered by Lenovo.

Table 92. External backup options

Part number	Description
External RDX USB drives	
4T27A10725	ThinkSystem RDX External USB 3.0 Dock
External SAS tape backup drives	
6160S7E	IBM TS2270 Tape Drive Model H7S
6160S8E	IBM TS2280 Tape Drive Model H8S
6160S9E	IBM TS2290 Tape Drive Model H9S
External SAS tape backup autoloaders	
6171S7R	IBM TS2900 Tape Autoloader w/LTO7 HH SAS
6171S8R	IBM TS2900 Tape Autoloader w/LTO8 HH SAS
6171S9R	IBM TS2900 Tape Autoloader w/LTO9 HH SAS
External tape backup libraries	
6741A1F	IBM TS4300 3U Tape Library-Base Unit
6741A3F	IBM TS4300 3U Tape Library-Expansion Unit
Full High 8 Gb Fibre Channel for TS4300	
01KP938	LTO 7 FH Fibre Channel Drive
01KP954	LTO 8 FH Fibre Channel Drive
02JH837	LTO 9 FH Fibre Channel Drive
Half High 8 Gb Fibre Channel for TS4300	
01KP936	LTO 7 HH Fibre Channel Drive
01KP952	LTO 8 HH Fibre Channel Drive
02JH835	LTO 9 HH Fibre Channel Drive
Half High 6 Gb SAS for TS4300	
01KP937	LTO 7 HH SAS Drive
01KP953	LTO 8 HH SAS Drive
02JH836	LTO 9 HH SAS Drive

For more information, see the list of Product Guides in the Backup units category:

<https://lenovopress.com/servers/options/backup>

Fibre Channel SAN switches

Lenovo offers the ThinkSystem DB Series of Fibre Channel SAN switches for high-performance storage expansion. See the DB Series product guides for models and configuration options:

- ThinkSystem DB Series SAN Switches:
<https://lenovopress.com/storage/switches/rack#rt=product-guide>

Uninterruptible power supply units

The following table lists the uninterruptible power supply (UPS) units that are offered by Lenovo.

Table 93. Uninterruptible power supply units

Part number	Description
55941AX	RT1.5kVA 2U Rack or Tower UPS (100-125VAC)
55941KX	RT1.5kVA 2U Rack or Tower UPS (200-240VAC)
55942AX	RT2.2kVA 2U Rack or Tower UPS (100-125VAC)
55942KX	RT2.2kVA 2U Rack or Tower UPS (200-240VAC)
55943AX	RT3kVA 2U Rack or Tower UPS (100-125VAC)
55943KX	RT3kVA 2U Rack or Tower UPS (200-240VAC)
55945KX	RT5kVA 3U Rack or Tower UPS (200-240VAC)
55946KX	RT6kVA 3U Rack or Tower UPS (200-240VAC)
55948KX	RT8kVA 6U Rack or Tower UPS (200-240VAC)
55949KX	RT11kVA 6U Rack or Tower UPS (200-240VAC)
55948PX	RT8kVA 6U 3:1 Phase Rack or Tower UPS (380-415VAC)
55949PX	RT11kVA 6U 3:1 Phase Rack or Tower UPS (380-415VAC)
55943KT†	ThinkSystem RT3kVA 2U Standard UPS (200-230VAC) (2x C13 10A, 2x GB 10A, 1x C19 16A outlets)
55943LT†	ThinkSystem RT3kVA 2U Long Backup UPS (200-230VAC) (2x C13 10A, 2x GB 10A, 1x C19 16A outlets)
55946KT†	ThinkSystem RT6kVA 5U UPS (200-230VAC) (2x C13 10A outlets, 1x Terminal Block output)
5594XKT†	ThinkSystem RT10kVA 5U UPS (200-230VAC) (2x C13 10A outlets, 1x Terminal Block output)

† Only available in China and the Asia Pacific market.

For more information, see the list of Product Guides in the UPS category:

<https://lenovopress.com/servers/options/ups>

Power distribution units

The following table lists the power distribution units (PDUs) that are offered by Lenovo.

Table 94. Power distribution units

Part number	Feature code	Description	ANZ	ASEAN	Brazil	EET	MEA	RUCIS	WE	HTK	INDIA	JAPAN	LA	NA	PRC
0U Basic PDUs															
00YJ776	ATZY	0U 36 C13/6 C19 24A 1 Phase PDU	N	Y	Y	N	N	N	N	N	N	Y	Y	Y	N
00YJ777	ATZZ	0U 36 C13/6 C19 32A 1 Phase PDU	Y	Y	N	Y	Y	Y	Y	Y	Y	N	N	Y	Y
0U Switched and Monitored PDUs															
00YJ783	AU04	0U 12 C13/12 C19 Switched and Monitored 48A 3 Phase PDU	N	N	Y	N	N	N	Y	N	N	Y	Y	Y	N
00YJ781	AU03	0U 20 C13/4 C19 Switched and Monitored 24A 1 Phase PDU	N	N	Y	N	Y	N	Y	N	N	Y	Y	Y	N
1U Switched and Monitored PDUs															
4PU7A81117	BNDV	1U 18 C19/C13 switched and monitored 48A 3P WYE PDU - ETL	N	N	N	N	N	N	N	N	N	N	N	Y	N
4PU7A77467	BLC4	1U 18 C19/C13 Switched and Monitored 80A 3P Delta PDU	N	N	N	N	N	N	N	N	N	Y	N	Y	N
4PU7A77469	BLC6	1U 12 C19/C13 switched and monitored 60A 3P Delta PDU	N	N	N	N	N	N	N	N	N	N	N	Y	N
4PU7A77468	BLC5	1U 12 C19/C13 switched and monitored 32A 3P WYE PDU	Y	Y	Y	Y	Y	Y	Y	Y	Y	N	Y	Y	Y
4PU7A81118	BNDW	1U 18 C19/C13 switched and monitored 48A 3P WYE PDU - CE	Y	Y	Y	Y	Y	Y	Y	Y	Y	N	Y	N	Y
1U Ultra Density Enterprise PDUs (9x IEC 320 C13 + 3x IEC 320 C19 outlets)															
71763NU	6051	Ultra Density Enterprise C19/C13 PDU 60A/208V/3PH	N	N	Y	N	N	N	N	N	N	Y	Y	Y	N
71762NX	6091	Ultra Density Enterprise C19/C13 PDU Module	Y	Y	Y	Y	Y	Y	Y	Y	Y	Y	Y	Y	Y
1U C13 Enterprise PDUs (12x IEC 320 C13 outlets)															
39Y8941	6010	DPI C13 Enterprise PDU Module (WW)	Y	Y	Y	Y	Y	Y	Y	Y	Y	Y	Y	Y	Y
1U Front-end PDUs (3x IEC 320 C19 outlets)															
39Y8938	6002	DPI Single-phase 30A/120V Front-end PDU (US)	Y	Y	Y	Y	Y	Y	Y	Y	Y	Y	Y	Y	Y
39Y8939	6003	DPI Single-phase 30A/208V Front-end PDU (US)	Y	Y	Y	Y	Y	Y	Y	Y	Y	Y	Y	Y	Y
39Y8934	6005	DPI Single-phase 32A/230V Front-end PDU (International)	Y	Y	Y	Y	Y	Y	Y	Y	Y	Y	Y	Y	Y
39Y8940	6004	DPI Single-phase 60A/208V Front-end PDU (US)	Y	N	Y	Y	Y	Y	Y	N	N	Y	Y	Y	N
39Y8935	6006	DPI Single-phase 63A/230V Front-end PDU (International)	Y	Y	Y	Y	Y	Y	Y	Y	Y	Y	Y	Y	Y
1U NEMA PDUs (6x NEMA 5-15R outlets)															
39Y8905	5900	DPI 100-127V NEMA PDU	Y	Y	Y	Y	Y	Y	Y	Y	Y	Y	Y	Y	Y

Part number	Feature code	Description	ANZ	ASEAN	Brazil	EET	MEA	RUCIS	WE	HTK	INDIA	JAPAN	LA	NA	PRC
Line cords for 1U PDUs that ship without a line cord															
40K9611	6504	4.3m, 32A/380-415V, EPDU/IEC 309 3P+N+G 3ph wye (non-US) Line Cord	Y	Y	Y	Y	Y	Y	Y	Y	Y	Y	Y	Y	Y
40K9612	6502	4.3m, 32A/230V, EPDU to IEC 309 P+N+G (non-US) Line Cord	Y	Y	Y	Y	Y	Y	Y	Y	Y	Y	Y	Y	Y
40K9613	6503	4.3m, 63A/230V, EPDU to IEC 309 P+N+G (non-US) Line Cord	Y	Y	Y	Y	Y	Y	Y	Y	Y	Y	Y	Y	Y
40K9614	6500	4.3m, 30A/208V, EPDU to NEMA L6-30P (US) Line Cord	Y	Y	Y	Y	Y	Y	Y	Y	Y	Y	Y	Y	Y
40K9615	6501	4.3m, 60A/208V, EPDU to IEC 309 2P+G (US) Line Cord	N	N	Y	N	N	N	Y	N	N	Y	Y	Y	N
40K9617	6505	4.3m, 32A/230V, Souriau UTG Female to AS/NZ 3112 (Aus/NZ) Line Cord	Y	Y	Y	Y	Y	Y	Y	Y	Y	Y	Y	Y	Y
40K9618	6506	4.3m, 32A/250V, Souriau UTG Female to KSC 8305 (S. Korea) Line Cord	Y	Y	Y	Y	Y	Y	Y	Y	Y	Y	Y	Y	Y

For more information, see the Lenovo Press documents in the PDU category:
<https://lenovopress.com/servers/options/pdu>

Rack cabinets

The following table lists the supported rack cabinets.

Table 95. Rack cabinets

Part number	Description
93072RX	25U Standard Rack (1000mm)
93072PX	25U Static S2 Standard Rack (1000mm)
7D6DA007WW	ThinkSystem 42U Onyx Primary Heavy Duty Rack Cabinet (1200mm)
7D6DA008WW	ThinkSystem 42U Pearl Primary Heavy Duty Rack Cabinet (1200mm)
93604PX	42U 1200mm Deep Dynamic Rack
93614PX	42U 1200mm Deep Static Rack
93634PX	42U 1100mm Dynamic Rack
93634EX	42U 1100mm Dynamic Expansion Rack
93074RX	42U Standard Rack (1000mm)
7D6EA009WW	ThinkSystem 48U Onyx Primary Heavy Duty Rack Cabinet (1200mm)
7D6EA00AWW	ThinkSystem 48U Pearl Primary Heavy Duty Rack Cabinet (1200mm)

For specifications about these racks, see the Lenovo Rack Cabinet Reference, available from:
<https://lenovopress.com/lp1287-lenovo-rack-cabinet-reference>

For more information, see the list of Product Guides in the Rack cabinets category:
<https://lenovopress.com/servers/options/racks>

KVM console options

The following table lists the supported KVM consoles.

Table 96. KVM console

Part number	Description
4XF7A84188	ThinkSystem 18.5" LCD Console (with US English keyboard)

The following table lists the available KVM switches and the options that are supported with them.

Table 98. KVM switches and options

Part number	Description
KVM Console switches	
1754D2X	Global 4x2x32 Console Manager (GCM32)
1754D1X	Global 2x2x16 Console Manager (GCM16)
1754A2X	Local 2x16 Console Manager (LCM16)
1754A1X	Local 1x8 Console Manager (LCM8)
Cables for GCM and LCM Console switches	
46M5383	Virtual Media Conversion Option Gen2 (VCO2)
46M5382	Serial Conversion Option (SCO)

For more information, see the list of Product Guides in the KVM Switches and Consoles category:

<http://lenovopress.com/servers/options/kvm>

Lenovo Financial Services

Lenovo Financial Services reinforces Lenovo's commitment to deliver pioneering products and services that are recognized for their quality, excellence, and trustworthiness. Lenovo Financial Services offers financing solutions and services that complement your technology solution anywhere in the world.

We are dedicated to delivering a positive finance experience for customers like you who want to maximize your purchase power by obtaining the technology you need today, protect against technology obsolescence, and preserve your capital for other uses.

We work with businesses, non-profit organizations, governments and educational institutions to finance their entire technology solution. We focus on making it easy to do business with us. Our highly experienced team of finance professionals operates in a work culture that emphasizes the importance of providing outstanding customer service. Our systems, processes and flexible policies support our goal of providing customers with a positive experience.

We finance your entire solution. Unlike others, we allow you to bundle everything you need from hardware and software to service contracts, installation costs, training fees, and sales tax. If you decide weeks or months later to add to your solution, we can consolidate everything into a single invoice.

Our Premier Client services provide large accounts with special handling services to ensure these complex transactions are serviced properly. As a premier client, you have a dedicated finance specialist who manages your account through its life, from first invoice through asset return or purchase. This specialist develops an in-depth understanding of your invoice and payment requirements. For you, this dedication provides a high-quality, easy, and positive financing experience.

For your region-specific offers, please ask your Lenovo sales representative or your technology provider about the use of Lenovo Financial Services. For more information, see the following Lenovo website:

<https://www.lenovo.com/us/en/landingpage/lenovo-financial-services/>

Seller training courses

The following sales training courses are offered for employees and partners (login required). Courses are listed in date order.

- 1. Lenovo Data Center Product Portfolio**
2023-07-21 | 15 minutes | Employees and Partners

This course introduces the Lenovo data center portfolio, and covers servers, storage, storage networking, and software-defined infrastructure products. After completing this course about Lenovo data center products, you will be able to identify product types within each data center family, describe Lenovo innovations that this product family or category uses, and recognize when a specific product should be selected.

Published: 2023-07-21

Length: 15 minutes

Employee link: Grow@Lenovo

Partner link: [Lenovo Partner Learning](#)

Course code: SXXW1110r6

2. **Family Portfolio: ThinkSystem AMD Rackmount Servers**

2023-06-07 | 15 minutes | Employees and Partners

This course adds AI capability information, specifically Lenovo OVX 3.0, about AMD rackmount servers. After completing this course, you will be able to identify products and features within the ThinkSystem AMD rack server family, describe unique innovations that this product family uses, and recognize when a specific product should be selected. You will also be able to describe how AMD rackmount servers are used in AI environments.

Published: 2023-06-07

Length: 15 minutes

Employee link: [Grow@Lenovo](#)

Partner link: [Lenovo Partner Learning](#)

Course code: SXXW1216r6

3. **Introduction to the AMD EPYC Gen4 Processors**

2022-12-30 | 10 minutes | Employees and Partners

After completing this course, you should be able to describe the Gen4 AMD EPYC™ processors, discuss the new and improved features of the Gen4 processors, and describe the customer benefits of the AMD EPYC Gen4 processors. You should also be able to list the Lenovo servers that use AMD EPYC Gen4 processors.

Published: 2022-12-30

Length: 10 minutes

Employee link: [Grow@Lenovo](#)

Partner link: [Lenovo Partner Learning](#)

Course code: SXXW2501

4. **Partner Technical Webinar - ThinkSystem AMD V3 servers**

2022-11-22 | 60 minutes | Partners Only

In this 60-minute replay, Mark Bica and Joe Murphy presented the details of the new announced ThinkSystem Servers V3 based on the new 4th Generation AMD EPYC processor. They presented the ThinkSystem SR645 V3, SR665 V3, SR675 V3, SD665 V3 and SD665-N V3.

Published: 2022-11-22

Length: 60 minutes

Partner link: [Lenovo Partner Learning](#)

Course code: 111822

5. **ThinkSystem AMD Rack Servers Preview Oct 22**

2022-10-26 | 3 minutes | Employees and Partners

This Quick Hit introduces three new Lenovo ThinkSystem rackmount servers that use AMD EPYC Gen4 processors. The SR645 V3, SR665 V3, and SR675 V3 are two-socket servers that support TruDDR5 memory and PCIe Gen5.

After completing this Quick Hit, you will be able to identify the new servers within the family, describe why the new servers are important to a customer, and recognize keywords that lead to using the new servers.

Published: 2022-10-26

Length: 3 minutes

Employee link: [Grow@Lenovo](#)

Partner link: [Lenovo Partner Learning](#)

Course code: SXXW1216r4a

6. Lenovo Infrastructure Solutions Launch
2022-09-16 | 8 minutes | Employees and Partners

This Quick Hit introduces a wealth of new products, solutions, and services announced as part of the Lenovo ThinkSystem 30th Anniversary celebration.

Published: 2022-09-16
Length: 8 minutes
Employee link: [Grow@Lenovo](#)
Partner link: [Lenovo Partner Learning](#)
Course code: FY23Q2a

7. Lenovo Sustainable Computing
2022-09-16 | 4 minutes | Employees and Partners

This Quick Hit describes the Lenovo sustainable computing program, and the many ways in which Lenovo strives to respect and protect the environment.

Published: 2022-09-16
Length: 4 minutes
Employee link: [Grow@Lenovo](#)
Partner link: [Lenovo Partner Learning](#)
Course code: SXXW2504a

8. Introduction to DDR5 Memory
2022-08-23 | 10 minutes | Employees and Partners

This course introduces DDR5 memory, describes new features of this memory generation, and discusses the advantages to customers of this new memory generation.

Published: 2022-08-23
Length: 10 minutes
Employee link: [Grow@Lenovo](#)
Partner link: [Lenovo Partner Learning](#)
Course code: SXXW2502

9. Intel Transparent Supply Chain on Lenovo Servers
2021-12-03 | 12 minutes | Employees and Partners

This course introduces the Intel Transparent Supply Chain (TSC) program, explains how the program works, and discusses the benefits of the Intel TSC program to customers. Adding the Intel TSC feature to an order is explained.

Published: 2021-12-03
Length: 12 minutes
Employee link: [Grow@Lenovo](#)
Partner link: [Lenovo Partner Learning](#)
Course code: SXXW1230

10. Family Portfolio: Cloud

2021-10-25 | 20 minutes | Employees and Partners

This course provides Lenovo sales and business partners an overview of Lenovo cloud solutions. This includes turnkey solutions, building blocks for cloud, engineered solutions, and professional services.

Learning Objectives:

- Explain ThinkAgile software-defined infrastructure products
- Explain engineered solution
- Explain the benefits of Lenovo cloud services
- Learn when to select a product, solution or service

Published: 2021-10-25

Length: 20 minutes

Employee link: [Grow@Lenovo](#)

Partner link: [Lenovo Partner Learning](#)

Course code: SXTW1001r3

11. Family Portfolio: Storage Controller Options

2021-10-19 | 25 minutes | Employees and Partners

This course covers the storage controller options available for use in Lenovo servers. The classes of storage controller are discussed, along with a discussion of where they are used, and which to choose.

Learning Objectives:

After completing this course, you will be able to:

- Describe the classes of storage controllers
- Discuss where each controller class is used
- Describe the available options in each controller class

Published: 2021-10-19

Length: 25 minutes

Employee link: [Grow@Lenovo](#)

Partner link: [Lenovo Partner Learning](#)

Course code: SXXW1111

Related publications and links

For more information, see these resources:

- ThinkSystem SR665 V3 product page:
<https://www.lenovo.com/us/en/p/servers-storage/servers/racks/thinksystem-sr665-v3/len21ts0009>
- ThinkSystem SR665 V3 datasheet
<https://lenovopress.com/ds0148>
- Interactive 3D Tour of the ThinkSystem SR665 V3:
<https://lenovopress.lenovo.com/lp1628-sr665-v3-3d-tour>
- ThinkSystem SR665 V3 drivers and support
<http://datacentersupport.lenovo.com/products/servers/thinksystem/sr665v3/7d9a/downloads>
- Lenovo Hardware Installation & Removal Videos on the SR665 V3:
https://www.youtube.com/playlist?list=PLYV5R7hVcs-DR4X1YAc9wFKhwj_tLQ5Y
- Lenovo ThinkSystem SR665 V3 product publications:
<https://pubs.lenovo.com/sr665-v3/>
 - User Guide, which includes:
 - System Configuration Guide
 - Hardware Maintenance Guide
 - Rack Installation Guides
 - Messages and Codes Reference
 - UEFI Manual for ThinkSystem Servers
- User Guides for options:
<https://serveroption.lenovo.com>
- ServerProven hardware compatibility:
<http://serverproven.lenovo.com>

Related product families

Product families related to this document are the following:

- [2-Socket Rack Servers](#)
- [ThinkSystem SR665 V3 Server](#)

Notices

Lenovo may not offer the products, services, or features discussed in this document in all countries. Consult your local Lenovo representative for information on the products and services currently available in your area. Any reference to a Lenovo product, program, or service is not intended to state or imply that only that Lenovo product, program, or service may be used. Any functionally equivalent product, program, or service that does not infringe any Lenovo intellectual property right may be used instead. However, it is the user's responsibility to evaluate and verify the operation of any other product, program, or service. Lenovo may have patents or pending patent applications covering subject matter described in this document. The furnishing of this document does not give you any license to these patents. You can send license inquiries, in writing, to:

Lenovo (United States), Inc.
8001 Development Drive
Morrisville, NC 27560
U.S.A.
Attention: Lenovo Director of Licensing

LENOVO PROVIDES THIS PUBLICATION "AS IS" WITHOUT WARRANTY OF ANY KIND, EITHER EXPRESS OR IMPLIED, INCLUDING, BUT NOT LIMITED TO, THE IMPLIED WARRANTIES OF NON-INFRINGEMENT, MERCHANTABILITY OR FITNESS FOR A PARTICULAR PURPOSE. Some jurisdictions do not allow disclaimer of express or implied warranties in certain transactions, therefore, this statement may not apply to you.

This information could include technical inaccuracies or typographical errors. Changes are periodically made to the information herein; these changes will be incorporated in new editions of the publication. Lenovo may make improvements and/or changes in the product(s) and/or the program(s) described in this publication at any time without notice.

The products described in this document are not intended for use in implantation or other life support applications where malfunction may result in injury or death to persons. The information contained in this document does not affect or change Lenovo product specifications or warranties. Nothing in this document shall operate as an express or implied license or indemnity under the intellectual property rights of Lenovo or third parties. All information contained in this document was obtained in specific environments and is presented as an illustration. The result obtained in other operating environments may vary. Lenovo may use or distribute any of the information you supply in any way it believes appropriate without incurring any obligation to you.

Any references in this publication to non-Lenovo Web sites are provided for convenience only and do not in any manner serve as an endorsement of those Web sites. The materials at those Web sites are not part of the materials for this Lenovo product, and use of those Web sites is at your own risk. Any performance data contained herein was determined in a controlled environment. Therefore, the result obtained in other operating environments may vary significantly. Some measurements may have been made on development-level systems and there is no guarantee that these measurements will be the same on generally available systems. Furthermore, some measurements may have been estimated through extrapolation. Actual results may vary. Users of this document should verify the applicable data for their specific environment.

© Copyright Lenovo 2023. All rights reserved.

This document, LP1608, was created or updated on November 24, 2023.

Send us your comments in one of the following ways:

- Use the online Contact us review form found at:
<https://lenovopress.lenovo.com/LP1608>
- Send your comments in an e-mail to:
comments@lenovopress.com

This document is available online at <https://lenovopress.lenovo.com/LP1608>.

Trademarks

Lenovo and the Lenovo logo are trademarks or registered trademarks of Lenovo in the United States, other countries, or both. A current list of Lenovo trademarks is available on the Web at <https://www.lenovo.com/us/en/legal/copytrade/>.

The following terms are trademarks of Lenovo in the United States, other countries, or both:

Lenovo®
AnyBay®
Bootable Media Creator
Flex System
Lenovo Services
ServerProven®
System x®
ThinkShield®
ThinkServer®
ThinkSystem®
TopSeller
UpdateXpress System Packs
XClarity®

The following terms are trademarks of other companies:

Intel® and Xeon® are trademarks of Intel Corporation or its subsidiaries.

Linux® is the trademark of Linus Torvalds in the U.S. and other countries.

Microsoft®, ActiveX®, PowerShell, Windows PowerShell®, Windows Server®, and Windows® are trademarks of Microsoft Corporation in the United States, other countries, or both.

SPECpower® is a trademark of the Standard Performance Evaluation Corporation (SPEC).

Other company, product, or service names may be trademarks or service marks of others.