Artistic Immersion, Overwhelming Captivation

VM5E series

The impressive immersion generated by the extremely narrow 0.9 mm bezel becomes even more powerful with a state-of-the-art smart signage platform. Beyond the self-playing feature, the VM5E series is capable of multitasking that raises brand awareness, drives traffic to your store, and engages customers in brand storytelling, all while providing user convenience with a simplified and more intuitive UI.



* All images are for illustrative purposes only.

Artistic Immersion, Overwhelming Captivation

VM5E series

Achieving Incredible Immersion

Seamless Large Screens with Extreme-Narrow Bezel

The borderless design, with its 0.9 mm* even bezel and 1.8 mm* BtB (Bezel to Bezel), verified by Nemko, minimizes bezel interference and delivers immersive and seamless content on assembled video wall screens.



* The 0.9mm even panel bezel and 1.8mm BtB size (borderless type, no metal bezel) have been verified by Nemko, a global institution that tests and certifies electrical equipment.

Image Gap Reduction

The VM5E series includes an image improvement algorithm that can reduce image gaps among tiled displays when playing back videos. Objects located on the bezel boundaries are adjusted for a seamless viewing experience.



* The "Conventional" refers to displays which do not include an image improvement algorithm.

Artistic Immersion, Overwhelming Captivation

VM5E series

Vivid and Dynamic Picture Quality

Higher Viewing Angle

Large screens are usually positioned higher than human-eye level, making uniform picture quality essential for video walls. The viewing angle of the VM5E series is high enough to display vivid colors throughout the screen with no distortion.



45°* High Viewing Angle

Wider Viewing Angle

It is well known that LG IPS panel technology provides better control of liquid crystals, which in turn allows the screen to be viewed at virtually any angle. Thereby, the VM5E series captivates the attention of more viewers with lifelike colors, regardless of their viewing position.

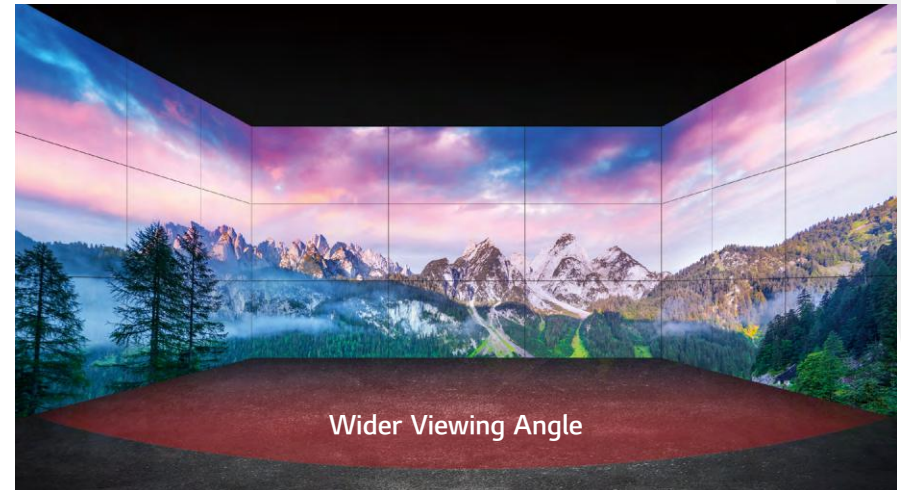

* Results based on in-house testing. Actual test results may differ depending on environment and measuring equipment.

Artistic Immersion, Overwhelming Captivation

VM5E series

Powerful Smart Signage Platform

High Performance and Great Scalability

Thanks to its built-in SoC and webOS smart signage platform, the VM5E series can execute several tasks at once while providing smooth content playback without the need for a media player. As webOS supports HTML5 as a web-based platform and offers SDK(Soft Development Kit), it is even easier for SIs to build and optimize their web apps.

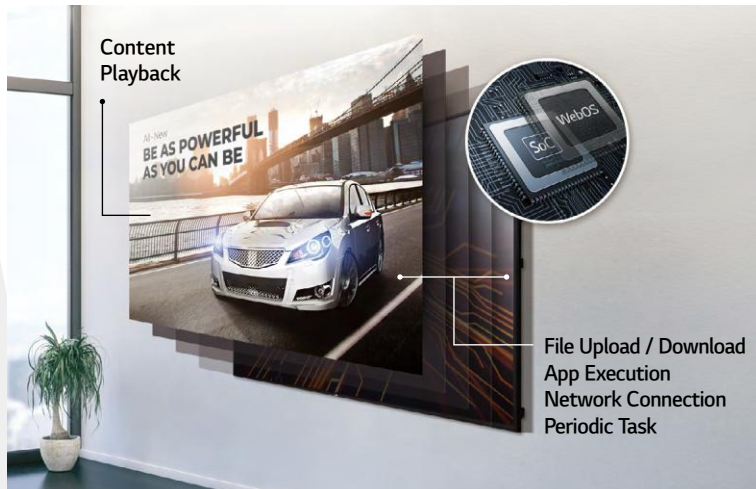

Flexible Content Creation

Four different videos can be played simultaneously via web apps, and various animation effects, such as scaling or rotating, are added to content using CSS(Cascading Style Sheets) transition effects. Real-time streaming* is also available, providing the flexibility to organize and diversify content free from capacity limits.



* Supported protocols : RTSP, RTP, HLS, UDP Multicast

Artistic Immersion, Overwhelming Captivation

VM5E series

User-Friendly Smart Signage UX

Intuitive Menu Structure

The menu structure has been optimized for commercial use. It simplifies approach flows and groups similar functions together, adopting a more intuitive GUI for ease of use. This way, users can avoid having to do trial-and-error when exploring desired functions and managing displays.

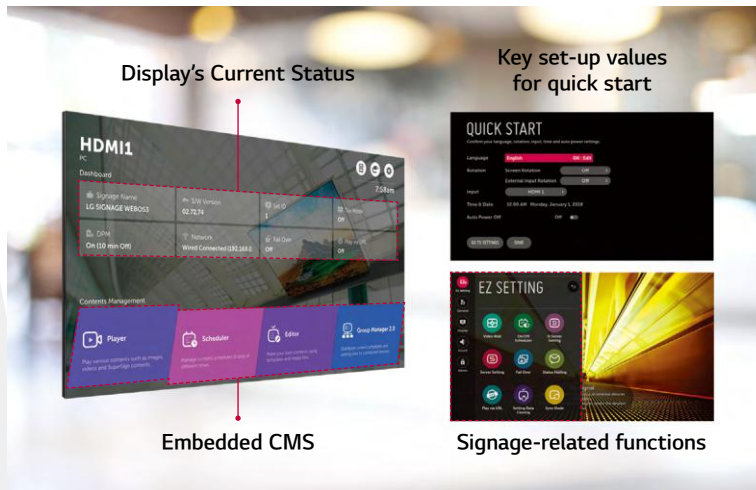

Dedicated GUI for Portrait Orientation

The conventional GUI (Graphic User Interface) was designed based on landscape-oriented consumer TV usage, so OSD (On Screen Display) wasn't well-suited for screens in portrait mode. The OSD of the VM5E series, however, consists of a long range menu with bigger font sizes and a 9:16 ratio, creating a comfortable and efficient business environment.

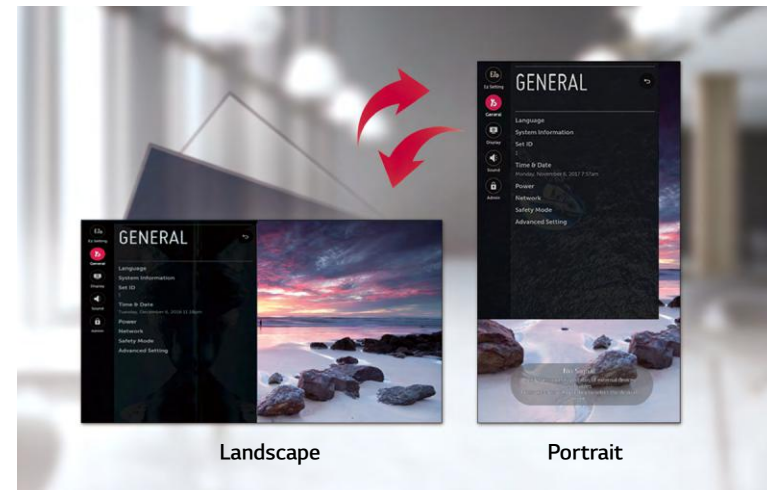

Artistic Immersion, Overwhelming Captivation

VM5E series

User Convenience

Easy Color Adjustment

Depending on the content, the color temperature of the display can be easily adjusted in increments of 100K using a remote control.

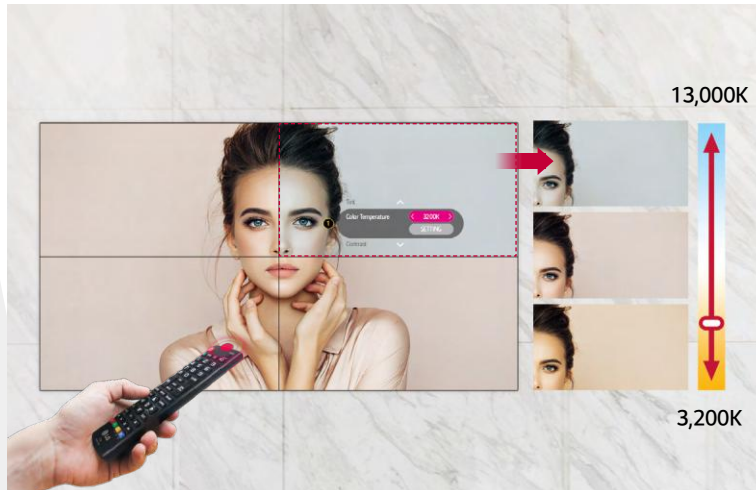

Simple White Balance Adjustment

In conventional video walls, white balance was adjustable only in “full-white” mode, but the VM5E series allows you to modify each value of grey scale to achieve more detailed and precise white balance adjustment.

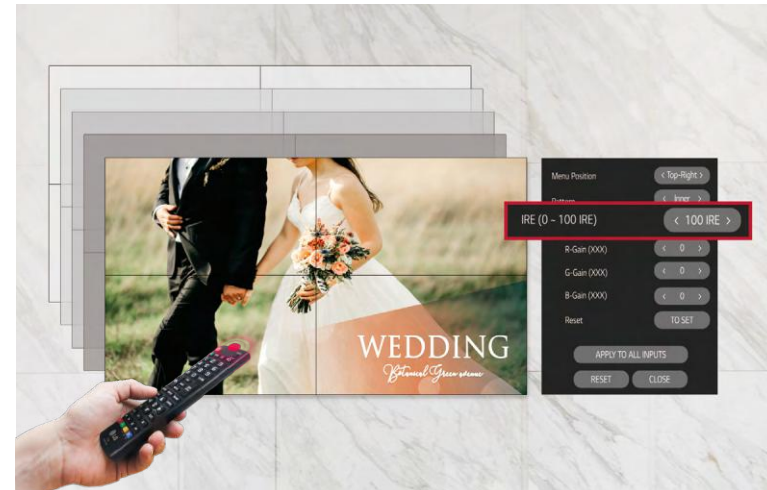

Artistic Immersion, Overwhelming Captivation

VM5E series

User Convenience

LAN Daisy Chain Management

A LAN daisy chain allows you to execute commands to control and monitor video walls and even update their firmwares at once.



Real-Time Care Service

The maintenance gets easier and faster with an optional service Signage365Care*, a cloud service solution provided by LG service. It remotely manages status of displays in client workplaces for fault diagnosis and remote-control services, ensuring the stable operation of a client's business.



* The availability of Signage365Care service can differ by region, so please contact the LG sales representative in your region for further details.

Dimension (Unit: mm)

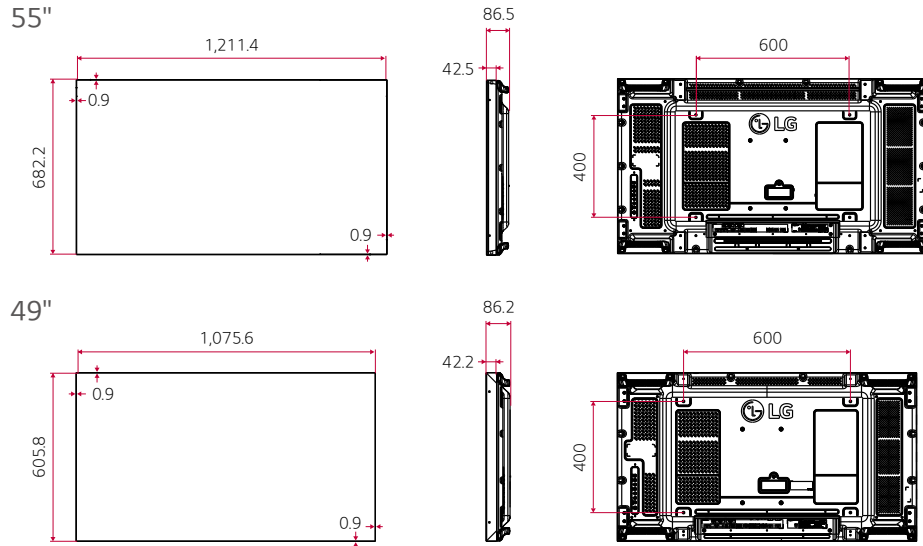

Connectivity

55" / 49"

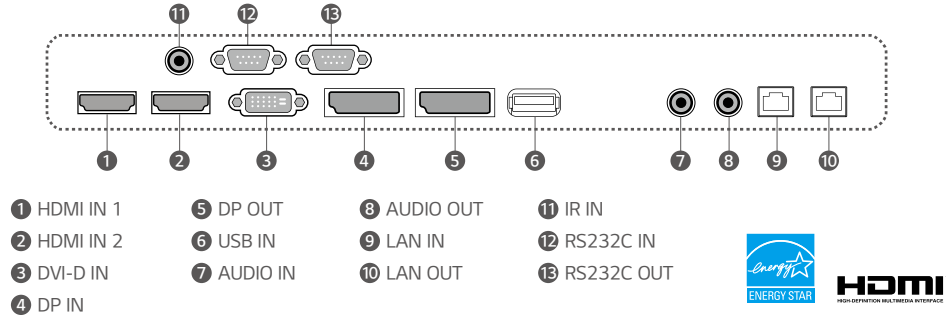

* Dimensions & Jack Panels (Read/Side) may differ from the above image, so please contact LG sales team to verify before ordering.

Specifications

	55VM5E	49VM5E	
PANEL	Screen Size	55"	49"
	Panel Technology	IPS	IPS
	Native Resolution	1,920 × 1,080 (FHD)	1,920 × 1,080 (FHD)
	Brightness (Typ.)	500 nit	500 nit
	Contrast Ratio	1,400 : 1	1,300 : 1
	Dynamic CR ¹⁾	500,000 : 1	500,000 : 1
	Color Gamut	NTSC 72 %	NTSC 72 %
	Viewing Angle (H × V)	178 × 178	178 × 178
	Color Depth	1.06 Billion Colors (10 bit)	1.07 Billion Colors (10 bit)
	Response Time	8 ms (G to G)	8 ms (G to G)
	Surface Treatment	Haze 3 %	Haze 3 %
	Operation Hours (Hours / Day)	24 / 7	24 / 7
	Portrait / Landscape	Yes / Yes	Yes / Yes
CONNECTIVITY	Input	HDMI (2), DP, DVI-D, Audio, USB 2.0 Type A	HDMI (2), DP, DVI-D, Audio, USB 2.0 Type A
	Output	DP, Audio	DP, Audio
	External Control	RS232C In / Out, RJ45 (LAN) In / Out, IR In	RS232C In / Out, RJ45 (LAN) In / Out, IR In
MECHANICAL SPECIFICATION	Bezel Color	Black	Black
	Bezel Width	0.9 mm (Even Bezel)	0.9 mm (Even Bezel)
	Monitor Dimension (W × H × D)	1,211.4 × 682.2 × 86.5 mm	1,075.6 × 605.8 × 86.2 mm
	Weight (Head)	18.6 kg	17.5 kg
	Handle	Yes	Yes
VESA™ Standard Mount Interface	600 × 400 mm	600 × 400 mm	
KEY FEATURE	Internal Memory (8 GB), Temperature Sensor, Current Sensor, Local Key Operation, webOS 4.0, Embedded CMS (Local Contents Scheduling, Group Manager), USB Plug & Play, Fail Over, Background Image (Booting Logo Image, No Signal Image), Sync Mode (RS-232C Sync, Local Network Sync), Video Tag (2), Play via URL, Rotation (Screen Rotation, External Input Rotation), Gapless Playback, Tile Mode Setting (Max. 15 × 15), Setting Data Cloning, SNMP, ISM Method, Auto Set ID, Status Mailing, Control Manager, Crestron Connected ²⁾ , Smart Energy Saving, PM Mode, Wake on LAN, HDMI-CEC ³⁾ , SI Server Setting, webRTC, ProIdiom, W/B Setting by Grey Scale, Scan Inversion		
ENVIRONMENT CONDITIONS	Operation Temperature	0 °C to 40 °C	0 °C to 40 °C
	Operation Humidity	10 % to 80 %	10 % to 80 %
	Power Supply	AC 100 - 240 V ~, 50 / 60 Hz	AC 100 - 240 V ~, 50 / 60 Hz
POWER	Power Type	Built-In Power	Built-In Power
	Power Consumption	Typ. / Max. 160 W / 180 W	120 W / 140 W
		BTU 546 BTU / Hr (Typ.), 614 BTU / Hr (Max.)	409 BTU / Hr (Typ.), 478 BTU / Hr (Max.)
CERTIFICATION	Safety	CB / NRTL	CB / NRTL
	EMC	FCC Class "A" / CE / KC	FCC Class "A" / CE / KC
MEDIA PLAYER COMPATIBILITY	ErP	Yes (EU Only)	Yes (EU Only)
	OPS Type Compatible	Yes (Piggyback)	Yes (Piggyback)
SOFTWARE COMPATIBILITY	SuperSign CMS, SuperSign Control / Control+, SuperSign WB, SuperSign Media Editor, Signage365Care ⁴⁾		
ACCESSORIES	Basic	Remote Controller, Power Cord, RS232C Cable, LAN Cable, DP Cable, IR Receiver, Guide Bracket, Screws, Manual	
	Optional	Wall Mount (Landscape : WM-L640V, Portrait : WM-P640V), OPS Kit (KT-OPSF)	

¹⁾ The luminosity ratio of Full Black / Full White color on video input condition.

²⁾ Network based control

³⁾ Compatibility may differ by equipment.

⁴⁾ The availability can differ by region.

* Specifications are subject to change without notice, so please contact LG sales team to verify before ordering.



Download
LG C-Display+
Mobile App

Google Play Store

- www.lg.com/b2b
- www.youtube.com/c/LGCommercialDisplay
- www.facebook.com/LGInformationDisplay
- www.linkedin.com/company/lginformationDisplay

LG may make changes to specifications and product descriptions without notice.
Copyright © 2020 LG Electronics Inc. All rights reserved. "LG Life's Good" is a registered trademark of LG Corp.
The names of products and brands mentioned here may be the trademarks of their respective owners.

